

TX-28/25LD4C Service Manual

Safety

Specifications

Parts List

Service
Information

Adjustments

Self Check

Service Hints

Mechanical
View

Disassembly

Location of
Controls

Waveforms

Block Diagrams

Schematic Diagrams

PCB Views

Service Support

Service and repair of this product is supported by Panasonic's LUCI interface.

This interface provides a link between the TV and a standard PC to allow a number of diagnostic and control functions to be performed.

For more details contact your local Panasonic company.

BACK

EXIT

Audio

Control

Power supply

Video



BACK

E - PCB

Y - PCB



BACK

E - Schematic

H - Schematic

N - Schematic

Y - Schematic



BACK

Service Manual



Colour Television

TX-28LD4C / TX-25LD4C

EURO4 Chassis

SPECIFICATIONS

(Information in brackets { } refer to TX-25LD4C)
Power Source: 220-240V AC, 50Hz
Power Consumption: 85W
Aerial Impedance: 75Ω unbalanced, Coaxial Type
Standby Power Consumption: 1,8W
Receiving System: PAL-B/G H, D/K, PAL-525/60
 SECAM B/G, D/K
 M.NTSC
 NTSC (AV only)

Receiving Channels:

VHF E2-E12 VHF H1-H2 (ITALY)
 VHF A-H (ITALY) VHF R1-R2
 VHF R3-R5 VHF R6-R12
 UHF E21-E69 CATV (S01-S05)
 CATV S1-S10 (M1-M10) CATV S11-S20 (U1-U10)
 CATV S21-S41 (HYPERBAND)

Intermediate Frequency:

Video 38,9MHz
 Sound 33,4MHz, 33,16MHz, 32,4MHz
 32,66MHz, 33,05MHz
 Colour 34,47MHz (PAL)
 34,5MHz, 34,65MHz (SECAM)

Video/Audio Terminals:

AUDIO MONITOR OUT
 AV1 IN Audio (RCAx2) 500mV rms 10kΩ
 Video (21 pin) 1V p-p 75Ω
 Audio (21 pin) 500mV rms 10kΩ
 RGB (21 pin)
 Video (21 pin) 1V p-p 75Ω
 AV1 OUT Audio (21 pin) 500mV rms 10kΩ
 AV2 IN S-Video IN Y: 1V p-p 75Ω
 (21 pin) C: 0.3V p-p 75Ω
 AV2 OUT Video (21 pin) 1V p-p 75Ω
 Audio (21 pin) 500mV rms 10kΩ
 AV3 IN Selectable Output (21 pin)
 Audio (RCAx2) 500mV rms 10kΩ
 Video (RCAx1) 1V p-p 75Ω

High Voltage: 28,5kV ±1kV {28,2kV ±1kV}

Picture Tube: A66ECF50X41 66cm
 {A59ECF50X41 59cm}

Audio Output: 2 x 15W (Music Power)
 8Ω Impedance

Headphones 8Ω Impedance

Accessories supplied: Remote Control
 2 x R6 (UM3) Batteries

Dimensions:

Height: 596,5 mm {550,5 mm}
 Width: 778 mm {730 mm}
 Depth: 479 mm {478,5 mm}
Net Weight: 32Kg {27kg}

Specifications are subject to change without notice.
 Weights and dimensions shown are approximate.

NOTE: This Service Manual should be used in conjunction with the EURO4 technical guide.

TECHNISCHE DATEN

(Werte in klammern gelten { } nur für TX-25LD4C)
Netzspannung: 220-240V AC, 50Hz
Leistungsaufnahme: 85W
Antennenimpedanz: 75Ω asymmetrisch, Koaxial-Typ
Standby Leistungsaufnahme: 1,8W
Empfangssystem: PAL-B/G H, D/K, PAL-525/60
 SECAM B/G, D/K
 M.NTSC
 NTSC (nur AV Eingang)

Empfangsbereiche:

VHF E2-E12 VHF H1-H2 (ITALY)
 VHF A-H (ITALY) VHF R1-R2
 VHF R3-R5 VHF R6-R12
 UHF E21-E69 CATV (S01-S05)
 CATV S1-S10 (M1-M10) CATV S11-S20 (U1-U10)
 CATV S21-S41 (HYPERBAND)

Zwischenfrequenz:

Video 38,9MHz
 Sound 33,4MHz, 33,16MHz, 32,4MHz
 32,66MHz, 33,05MHz
 Colour 34,47MHz (PAL)
 34,5MHz, 34,65MHz (SECAM)

Video/Audio Anschlüsse:

AUDIO MONITOR OUT
 AV1 EINGANG Audio (RCAx2) 500mV rms 10kΩ
 Video (21 pin) 1V p-p 75Ω
 Audio (21 pin) 500mV rms 10kΩ
 RGB (21 pin)
 Video (21 pin) 1V p-p 75Ω
 AV1 AUSGANG Audio (21 pin) 500mV rms 10kΩ
 AV2 EINGANG S-Video IN Y: 1V p-p 75Ω
 (21 pin) C: 0.3V p-p 75Ω
 AV2 AUSGANG Video (21 pin) 1V p-p 75Ω
 Audio (21 pin) 500mV rms 10kΩ
 AV3 EINGANG Wählbarer Ausgang
 Audio (RCAx2) 500mV rms 10kΩ
 Video (RCAx1) 1V p-p 75Ω

Hochspannung: 28,5kV ±1kV {28,2kV ±1kV}

Bildrohre: A66ECF50X41 66cm
 {A59ECF50X41 59cm}

Ton Ausgangsleistung: 2 x 15W (Musikleistung)
 Lautsprecher 8Ω Impedanz

Kopfhörer: 8Ω Impedanz

Mittel. Zubehör: Fernbedienung
 2 x R6 (UM3) Batterien

Abmessungen:

Höhe: 596,5 mm {550,5 mm}
 Breite: 778 mm {730 mm}
 Tiefe: 479 mm {478,5 mm}
Gewicht: 32Kg {27kg}

Änderungen der Technischen Daten vorbehalten.
 Gewichte und Abmessungen sind Näherungsangaben.

Hinweis: Bitte verwende Sie das Service Manual zusammen mit dem Technical Guide.

Panasonic

CONTENTS

SAFETY PRECAUTIONS	2
SERVICE HINTS	4
SERVICE MODE	5
SELF CHECK	7
ADJUSTMENT PROCEDURE	8
WAVEFORM PATTERN TABLE	9
ALIGNMENT SETTINGS	10
BLOCK DIAGRAMS.....	12
PARTS LOCATION.....	16
REPLACEMENT PARTS LIST.....	17
SCHEMATIC DIAGRAMS.....	26
CONDUCTOR VIEWS	30

SAFETY PRECAUTIONS

GENERAL GUIDE LINES

1. It is advisable to insert an isolation transformer in the AC supply before servicing a hot chassis.
2. When servicing, observe the original lead dress in the high voltage circuits. If a short circuit is found, replace all parts which have been overheated or damaged by the short circuit.
3. After servicing, see that all the protective devices such as insulation barriers, insulation papers, shields and isolation R-C combinations are correctly installed.
4. When the receiver is not being used for a long period of time, unplug the power cord from the AC outlet.
5. Potentials as high as 29,5kV {29,2kV} are present when this receiver is in operation. Operation of the receiver without the rear cover involves the danger of a shock hazard from the receiver power supply. Servicing should not be attempted by anyone who is not familiar with the precautions necessary when working on high voltage equipment. Always discharge the anode of the tube.
6. After servicing make the following leakage current checks to prevent the customer from being exposed to shock hazard.

LEAKAGE CURRENT COLD CHECK

1. Unplug the AC cord and connect a jumper between the two prongs of the plug.
2. Turn on the receiver's power switch.
3. Measure the resistance value with an ohmmeter, between the jumpered AC plug and each exposed metallic cabinet part on the receiver, such as screw heads, aerials, connectors, control shafts etc. When the exposed metallic part has a return path to the chassis the reading should be between 4M ohm and 20M ohm. When the exposed metal does not have a return path to the chassis the reading must be infinite.

INHALT

SICHERHEITSVORKEHRUNGEN	2
SERVICE HINWEISE	4
ABGLEICHVERFAHREN.....	6
SELBSTDIAGNOSE	7
ABGLEICH	8
SIGNAL TABELLE	9
ABGLEICHTABELLE	11
SCHALTBILD BLOCK.....	12
EXPLOSIONSZEICHNUNG.....	16
ERSATZTEILLISTE	17
SCHALTBILD SCHEMA	26
ANSICHT DER LEITERBAHNEN	30

SICHERHEITSVORKEHRUNGEN

ALLGEMEINE RICHTLINIEN

1. Es ist empfehlenswert einen Trenntransformator in die Stromversorgung zu schalten, bevor Reparaturen an einem Gerät vorgenommen werden, dessen Chassis unter Spannung steht.
2. Bei der Durchführung von Servicearbeiten dürfen die ursprünglichen Kabelanschlüsse nicht vertauscht werden. Dies gilt insbesondere für die Anschlüsse im Hochspannungsteil. Hat sich ein Kurzschluß ereignet, dann sind alle Teile, an denen Spuren von Überhitzung sichtbar sind, auszuwechseln.
3. Nach Beenden der Servicearbeiten ist sicherzustellen, daß alle Sicherheitsvorrichtungen, wie Isolationsstege, Isolationspapiere, Abschirmungen und Isolations -R-C- Glieder wieder richtig eingesetzt sind.
4. Wenn der Fernseher während längerer Zeit nicht in Betrieb gesetzt wird, sollte der Netzstecker aus der Netzsteckdose gezogen werden.
5. Im Betrieb sind Spannungen bis zu 29,5kV {29,2kV} in diesem Gerät vorhanden. Die Inbetriebnahme des Fernsehers ohne aufgesetzte Rückwand bringt die Gefahr eines elektrischen Schlages von der Fernseher - Stromversorgung mit sich. Servicearbeiten sollten daher auch nie durch Personen versucht werden, die nicht in vollem Umfang mit den Sicherheitsvorkehrungen beim Umgang mit Hochspannungsgeräten vertraut sind. Vor der Handhabung mit der Bildröhre ist die Anode der Bildröhre immer an dem Empfängerchassis zu entladen.
6. Nach Beenden der Servicearbeiten sind die folgenden Kriechstrom-Prüfungen durchzuführen, um den Kunden vor der Gefahr eines elektrischen Schlages zu schützen.

MESSUNG DES ISOLATIONSWIDERSTANDES IM ABGESCHALTETEN ZUSTAND

1. Den Netzstecker aus der Netzsteckdose ziehen und die beiden Steckerstifte kurzschließen.
2. Den Geräteschalter des Fernsehgerätes einschalten.
3. Mit einem Ohmmeter den Widerstandswert zwischen dem überbrückten Netzkabelstecker und jedem zugänglichen Metallteil am Gehäuse des Fernsehgerätes, wie Schraubenköpfe, Antennen, Achsen der Regler, Griffassungen usw. messen. Wenn ein zugängliches Metallteil keine Rückleitung zum Chassis hat, muß die Anzeige unendlich betragen.

LEAKAGE CURRENT HOT CHECK

1. Plug the AC cord directly into the AC outlet. Do not use an isolation transformer for this check.
2. Connect a 2k Ω 10w resistor in series with an exposed metallic part on the receiver and an earth, such as a water pipe.
3. Use an AC voltmeter with high impedance to measure the potential across the resistor.
4. Check each exposed metallic part and check the voltage at each point.
5. Reverse the AC plug at the outlet and repeat each of the above measurements.
6. The potential at any point should not exceed 1.4 V rms. In case a measurement is outside the limits specified, there is a possibility of a shock hazard, and the receiver should be repaired and rechecked before it is returned to the customer.

MESSUNG DES KRIECHSTROMS IM EINGESCHALTETEN ZUSTAND

1. Den Netzstecker direkt in eine Netzsteckdose stecken. Für diese Messung keinen Trenntransformator verwenden.
2. Einen 2k Ω / 10W-Widerstand in Serie mit einem von außen zugänglichen Metallteil am Fernsehgerät und einer guten, Erdung z.B Wasserleitung, anschließen.
3. Ein Wechselstrom-Voltmeter mit einem Meßbereich von 1000 Ohm.Volt oder größer verwenden, um die Spannung über den Widerstand zu messen.
4. Jedes zugängliche Metallteil prüfen, und an jedem Punkt dies Spannung messen.
5. Den Netzstecker umgekehrt in die Steckdose stecken und jede der obigen Messungen wiederholen.
6. Die Spannung darf an keinem der Punkte 1.4V eff. überschreiten. Wird dieser Wert nicht eingehalten, besteht die Gefahr eines elektrischen Schlages, und das Fernsehgerät sollte daher repariert und nachgeprüft werden, bevor es an den Kunden zurückgegeben wird.

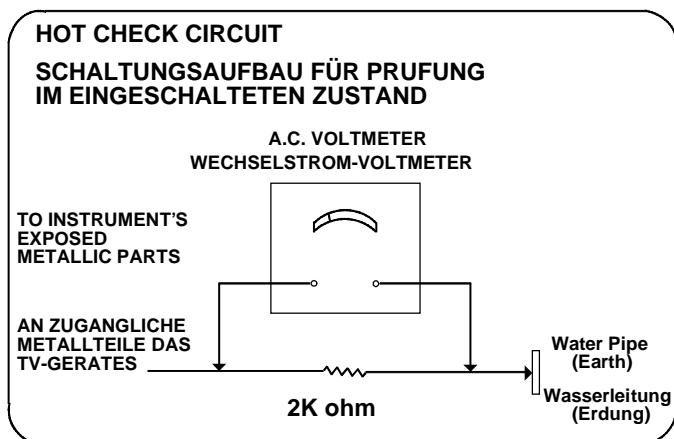

Fig.1.
Abb.1.

X-RADIATION WARNING

1. The potential sources of X-Radiation in TV sets are the high voltage section and the picture tube.
2. When using a picture tube test jig for service, ensure that the jig is capable of handling 29,5kV without causing X-Radiation.

NOTE : It is important to use an accurate periodically calibrated high voltage meter.

1. Set the brightness to minimum.
2. Measure the high voltage. The meter should indicate 28,5kV \pm 1kV {28,2kV \pm 1kV}. If the meter indication is out of tolerance, immediate service and correction is required to prevent the possibility of premature component failure.
3. To prevent any X-Radiation possibility, it is essential to use the specified tube.

RÖNTGENSTRAHLUNG ACHTUNG :

1. Potentielle Quellen von Röntgenstrahlung in Fernsehgeräten sind das Hochspannungsteil und die Bildröhre.
2. Bei Verwendung eines Bildröhren-Prüfgerätes für den Service ist sicherzustellen, daß es für die Belastung von 29,5kV geeignet ist, ohne daß eine Röntgenstrahlung verursacht wird.

ANMERKUNG : Es ist wichtig, daß ein präzises, regelmäßig geprüfetes Voltmeter verwendet wird.

1. Helligkeit auf Minimum stellen.
2. Die Hochspannung messen. Die Anzeige des Instrumentes sollte 28,5kV \pm 1kV {28,2kV \pm 1kV} Falls die Anzeige diese Toleranzgrenzen überschreitet, ist die sofortige Behebung nötig, um die Möglichkeit vorzeitigen Komponentenausfalls zu verhüten.
3. Um die Möglichkeit von Röntgenstrahlung zu begrenzen, ist es wichtig, daß nur die vorgeschriebene Bildröhre verwendet wird.

SERVICE HINTS

HOW TO REMOVE THE REAR COVER

1. Remove the 12 screws (A) as shown in **Fig.2**.

SERVICE HINWEISE

ENTFERNEN DER GERÄTERÜCKWAND

1. Die 12 Schrauben (A) entfernen, siehe **Abb.2**.



Screws A
Schrauben A
Fig.2
Abb.2

LOCATION OF CONTROLS

LAGE DER EINSTELLREGLER

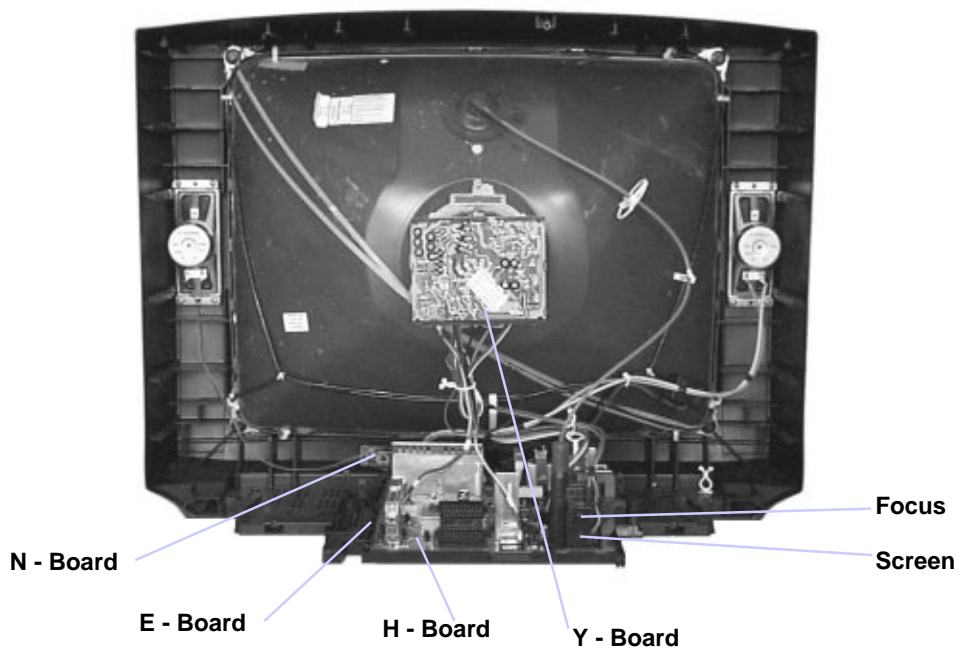

Fig.3
Abb.3

SERVICE MODE

The remote control is used for entering and storing adjustments, with the exception of Cut-off adjustments, which must always be done prior to service adjustment. Perform adjustments in accordance with screen display. The display on the screen also specifies the CCU variants as well as the approx. setting values. The adjustment sequence for the service mode is indicated below.

1. Set the Bass to maximum position, set the Treble to minimum position, press the volume down button (-/v) on the customer controls at the front of the TV and at the same time press the **INDEX** button on the remote control, this will place the TV into the Service Mode.

2. Press the **RED / GREEN** buttons to step up / down through the functions.
3. Press the **YELLOW / BLUE** buttons to alter the function values.
4. Press the **STR** button after each adjustment has been made to store the required values.
5. To exit the Service Mode, press the **"N"** button.

NOTE: This TV also has the option of using a Memory Pack which enables you to copy the preset TV channels into the Memory Pack and then download them onto this or any other EURO-4 TV set.

TV to Memory Pack process

1. Plug the memory pack into the AV1 21 pin terminal at the back of the TV and switch the TV on.
2. Go into Service Mode as explained above. The screen will show :-

Program
External>>TV

3. Press the **BLUE** button on the remote control. The screen will show :-

Program
TV>>External

4. Press the **STR** button on the remote control. The screen will show :-

Please Wait

5. All the tuning information stored inside the TV will now be transferred to the Memory Pack. This process will take 2-3 minutes to complete and when finished the screen will show :-

Complete

Memory Pack to TV process

1. Plug the memory pack into the AV1 21 pin terminal at the back of the TV and switch the TV on.
2. Go into the Service Mode as explained above. The screen will show :-

Program
External>>TV

3. Press the **STR** button on the remote control. The screen will show :-

Please Wait

4. All the tuning information stored inside the Memory Pack will now be transferred to the TV. This process will take 2-3 minutes to complete and when finished the screen will show :-

Complete

5. The tuning information from the Memory Pack has now been copied into the TV.
6. To exit from the Service Mode press the **"N"** button.
7. The process has now been completed and the Memory Pack can now be removed.

ERRORS

If an error occurs while using the Memory Pack the TV will detect this and the screen will show: -

Error !!

If this happens then press the **"N"** button and repeat the process that was being used. If the errors continue to occur then check the connectors between the TV and the memory pack and check the 9V battery inside the memory pack.

ABGLEICHVERFAHREN

Die Fernbedienung dient zum Eingeben und Abspeichern der Einstellwerte, mit Ausnahme der Sperrpunkteinstellung, die grundsätzlich vor den hier beschriebenen Einstellungen vorgenommen werden muss. Die Einstellungen erfolgen entsprechend dem Bildschirm-Display. Auf dem Bildschirm-Display erscheinen die ungefähren Einstellwerte. Die Einstellfolge für den Service-Modus ist nachstehend beschrieben.

1. Um in den Service-Mode zu gelangen, gehen sie bitte wie folgt vor.
2. Stellen sie im Toneinstellungs-Menü die Bässe auf Maximun und die Höhen auf Minimum.
3. Halten sie die **INDEX**-Taste auf der Fernbedienung gedrückt und drücken zusätzlich die Taste **-V** im Bedienteil des TV-Gerätes. Auf dem Bildschirm erscheint die entsprechende Anzeige für den Service-Mode.

4. Die einzelnen Funktionen mit Hilfe der **ROTEN** und **GRÜNEN** Taste anwählen.
5. Mit der **GELBEN** und **BLAUEN** Taste die Werte der einzelnen Funktionen ändern.
6. Nach jeder Einstellung die Taste **STR** auf der Fernbedienung drücken, um die geänderten Werte abzuspeichern.
7. Zum Verlassen des Service-Modus die **"N"** - Taste auf der Fernbedienung drücken.

HINWEIS: Dieses FS-Gerät bietet auch die Möglichkeit eines Memory Pack, mit dem Sie die gewählten Fernsehkanäle abspeichern und auf jedes beliebige EURO-4 FS-Gerät umkopieren können.

Kopieren der Einstelldaten vom FS-Gerät in das Memory Pack.

1. Das Memory Pack in die AV1-Buchse an der Rückseite des FS-Gerätes stecken und das Gerät einschalten.
2. Wie schon oben beschrieben auf Service-Modus umschalten. Auf dem Bildschirm erscheint :-

Program
External>>TV

3. Nun die **BLAUE** Taste an der Fernbedienung betätigen. Auf dem Bildschirm erscheint:-

Program
TV>>External

4. Die Taste **STR** Taste an der Fernbedienung betätigen.. Der Bildschirm meldet nun :-

Please Wait

5. Die im FS-Gerät abgespeicherten Kanal-Einstelldaten werden nun in das Memory Pack überspielt. Bei abgeschlossener Datenübertragung meldet der Bildschirm :-

Complete

Kopieren der Einstelldaten vom Memory Pack in das FS-Gerät.

1. Das Memory Pack in die AV1-Buchse an der Rückseite des FS-Gerätes stecken und das Gerät einschalten.
2. Wie schon oben beschrieben auf Service-Modus umschalten. Auf dem Bildschirm erscheint :-

Program
External>>TV

3. Die Taste **STR** Taste an der Fernbedienung betätigen.. Der Bildschirm meldet nun :-

Please Wait

4. Die im Memory Pack abgespeicherten Kanal-Einstelldaten werden nun in das FS-Gerät überspielt. Bei abgeschlossener Datenübertragung meldet der Bildschirm :-

Complete

5. Die Kanal-Einstelldaten sind damit von Memory Pack in das FS-Gerät überspielt.
6. Zum Verlassen des Service-Modus die **"N"** - Taste auf der Fernbedienung drücken.
7. Das Kopiervorgang ist somit abgeschlossen, und das Memory Pack kann von der Steckerleiste abgezogen werden.

FEHLER

Falls beim Gebrauch des Memory Packs Fehler auftreten, zeigt das FS-Gerät dies auf dem Bildschirm mit der folgenden Meldung an :-

Error !!

In diesem Fall muss der Service-Modus durch Drücken der **"N"** - Taste auf der Fernbedienung verlassen und anschliessend der Vorgang wiederholt werden. Falls weiterhin Fehlermeldungen erscheinen, müssen die Anschlusskontakte zwischen FS-Gerät und Memory Pack sowie die 9V Batterie im Memory Pack kontrolliert werden.

SELF CHECK

1. Self-check is used to automatically check the bus lines and hexadecimal code of the TV set.
2. To get into the Self-Check mode press the down **(-V)** button on the customer controls at the front of the set, at the same time pressing the **STATUS** button on the remote control, and the screen will show :-

SELBSTDIAGNOSE

1. Die Selbstdiagnose dient zum automatischen Prüfen der Bus-Leitungen sowie des Hexadezimalcodes des FS-Geräts. Zum Umschalten auf Selbstdiagnose zunächst die Taste "**STATUS**" auf der Fernbedienung und gleichzeitig die Taste am Bedienteil des FS-Gerätes drücken **(-V)**, auf dem Bildschirm erscheint hierauf :-
2. Nach der Selbstdiagnose wird das Gerät automatisch auf sämtliche werksseitigen Standardeinstellungen zurückgesetzt :-

VDP	O.K.	PCB	O.K.
TUN	O.K.	Cab	O.K.
E2	O.K.	Sum	Factory use only
MSP	O.K.		Nur für
DPL	- -		Herstellung
OPTION 1	39		
OPTION 2	0C		
OPTION 3	1F		
OPTION 4	00		
OPTION 5	EF		
OPTION 6	25		

Service Aids

To aid in the service of our current chassis there are a number of Service Aids which have been made available.

- **LUCI** interface kit (**Linked Utility Computer Interface**)
Part number: TZS6EZ002
This contains interface and cables for connecting TV service connector and a PC as well as diagnostic software. As new models are introduced upgrade software will become available.
- **VICI** (**Visual Interactive Computer Information**)
These C.D.'s contain multimedia documentation providing quick access to service information.
Part No. TZS7EZ006 & TZS7EZ005
 1. Service Manuals
 2. Instruction Books
 3. Technical Information
- **TASMIN** (**Technically Advanced System for Multimedia Interactive Notes**)
As well as providing a first step towards more interactive training this product also achieves quick access to Technical Information.

Service-Hilfen

Zur Unterstützung der Servicearbeiten stehen weitere Hilfsmittel zur Verfügung.

- **LUCI** interface kit (PC-unterstütztes Diagnosesystem)
Bestell-Nr.: TZS6EZ002
Es beinhaltet ein Interface, die Anschlusskabel zum FS-Gerät und die Diagnose-Software. Bei Einführung von neuen Modellen ist ein Update der Software jederzeit möglich.
- **VICI** (Interaktive CD-ROM) mit schnellem Zugriff auf Serviceinformationen.
Bestell-Nr.: TZS7EZ006 & TZS7EZ005
 1. Service Manuals
 2. Bedienungsanleitungen
 3. Technical Information
- **TASMIN** (Technisch erweitertes System für interaktive Multimedia-Hinweise und Notizen)
Genauso wie dieses Produkt einen ersten Schritt in Richtung erweitertes interaktives Training bereitstellt, ermöglicht es einen noch schnelleren Zugang zu technischen Informationen.

ADJUSTMENT PROCEDURE

Item/Preparation	Adjustments																														
<p style="text-align: center;">+B SET-UP</p> <ol style="list-style-type: none"> 1. Receive a Greyscale signal. 2. Set the controls:- <table style="margin-left: 20px;"> <tr> <td>Brightness</td> <td>Minimum</td> </tr> <tr> <td>Contrast</td> <td>Minimum</td> </tr> <tr> <td>Volume</td> <td>Minimum</td> </tr> </table> 	Brightness	Minimum	Contrast	Minimum	Volume	Minimum	<ol style="list-style-type: none"> 1. Set the +B voltage up as follows:- Adjust R811 so that B2 shows $148V \pm 1V$ 2. Confirm the following voltages. <table style="margin-left: 20px;"> <tr> <td>B9</td> <td>5 ± 0.25V</td> <td>B10</td> <td>5 ± 0.25V</td> </tr> <tr> <td>B5</td> <td>12 ± 0.5V</td> <td>B11</td> <td>33 ± 1.5V</td> </tr> <tr> <td>B4</td> <td>16 ± 1V</td> <td>B7</td> <td>8 ± 0.5V</td> </tr> <tr> <td>B12</td> <td>26 ± 1V</td> <td>B8</td> <td>5.5 ± 0.5V</td> </tr> <tr> <td>B3</td> <td>35 ± 1V</td> <td>B13</td> <td>15 ± 1V</td> </tr> <tr> <td>B1</td> <td>200 ± 10V</td> <td>B14</td> <td>-15 ± 1V</td> </tr> </table> 	B9	5 ± 0.25V	B10	5 ± 0.25V	B5	12 ± 0.5V	B11	33 ± 1.5V	B4	16 ± 1V	B7	8 ± 0.5V	B12	26 ± 1V	B8	5.5 ± 0.5V	B3	35 ± 1V	B13	15 ± 1V	B1	200 ± 10V	B14	-15 ± 1V
Brightness	Minimum																														
Contrast	Minimum																														
Volume	Minimum																														
B9	5 ± 0.25V	B10	5 ± 0.25V																												
B5	12 ± 0.5V	B11	33 ± 1.5V																												
B4	16 ± 1V	B7	8 ± 0.5V																												
B12	26 ± 1V	B8	5.5 ± 0.5V																												
B3	35 ± 1V	B13	15 ± 1V																												
B1	200 ± 10V	B14	-15 ± 1V																												
<p style="text-align: center;">Cut-Off / Ug2 Test</p> <ol style="list-style-type: none"> 1. Receive a Greyscale signal. 2. Degauss the tube externally. 3. Set the TV into Service Mode 1. 4. Select Cutoff mode. 	<p>To adjust Cutoff connect an oscilloscope to the blue cathode, adjust "cutoff" value using the "Yellow" and "Blue" buttons until the black level is $160V \pm 5V$ press "STR" to store the value. Remove the oscilloscope. Select Ug2 adjustment and adjust the screen VR until the display shows "O.K."</p>																														

ABGLEICH

Vorbereitungen	Abgleich																								
<p style="text-align: center;">+B - Abgleich</p> <ol style="list-style-type: none"> 1. Testbild empfangen. Helligkeit auf Minimum Kontrast auf Minimum Lautstärke Minimum 	<ol style="list-style-type: none"> 1. Mit R811 muß die B2 auf $148V \pm 1V$ eingestellt werden. 2. Folgende Spannungen sind zu überprüfen. <table style="margin-left: 20px;"> <tr> <td>B9</td> <td>5 ± 0.25V</td> <td>B10</td> <td>5 ± 0.25V</td> </tr> <tr> <td>B5</td> <td>12 ± 0.5V</td> <td>B11</td> <td>33 ± 1.5V</td> </tr> <tr> <td>B4</td> <td>16 ± 1V</td> <td>B7</td> <td>8 ± 0.5V</td> </tr> <tr> <td>B12</td> <td>26 ± 1V</td> <td>B8</td> <td>5.5 ± 0.5V</td> </tr> <tr> <td>B3</td> <td>35 ± 1V</td> <td>B13</td> <td>15 ± 1V</td> </tr> <tr> <td>B1</td> <td>200 ± 10V</td> <td>B14</td> <td>-15 ± 1V</td> </tr> </table> 	B9	5 ± 0.25V	B10	5 ± 0.25V	B5	12 ± 0.5V	B11	33 ± 1.5V	B4	16 ± 1V	B7	8 ± 0.5V	B12	26 ± 1V	B8	5.5 ± 0.5V	B3	35 ± 1V	B13	15 ± 1V	B1	200 ± 10V	B14	-15 ± 1V
B9	5 ± 0.25V	B10	5 ± 0.25V																						
B5	12 ± 0.5V	B11	33 ± 1.5V																						
B4	16 ± 1V	B7	8 ± 0.5V																						
B12	26 ± 1V	B8	5.5 ± 0.5V																						
B3	35 ± 1V	B13	15 ± 1V																						
B1	200 ± 10V	B14	-15 ± 1V																						
<p style="text-align: center;">Cut-Off / Ug2 Test</p> <ol style="list-style-type: none"> 1. Testbild empfangen. 2. Bildröhre entmagnetisieren. 3. Service-Mode 1 anwählen. 4. Im Service-Mode den Abgleichpunkt Cutoff DC-Mode wählen . 	<p>Einen Oszillographen an die blaue Katode der Bildröhre anschliessen. Mit der gelben und blauen Taste den CUT-OFF Wert auf $160V \pm 5V$ abgleichen und mit der STR-Taste abspeichern. Den Oszillograph entfernen und den Ug2 Test aufrufen. Den Abgleichwert solange ändern, bis OK auf dem Bildschirm erscheint. Den Wert abspeichern.</p>																								

WAVEFORM PATTERN TABLE SIGNAL TABELLE

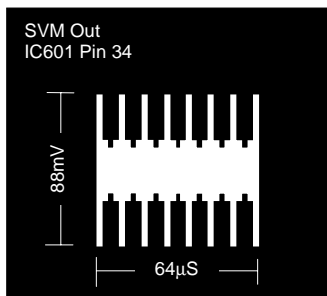
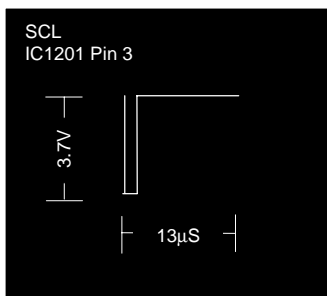
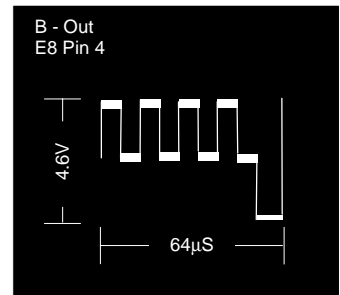
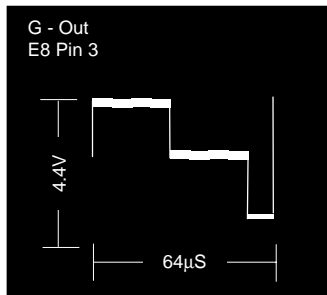
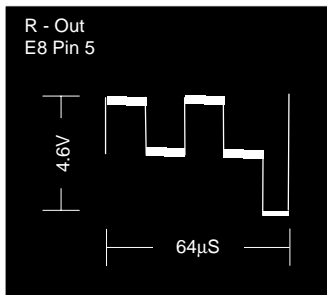
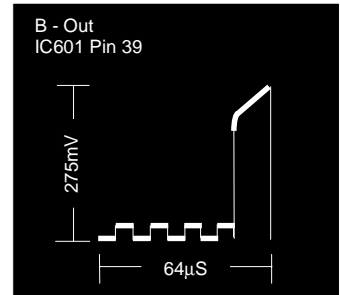
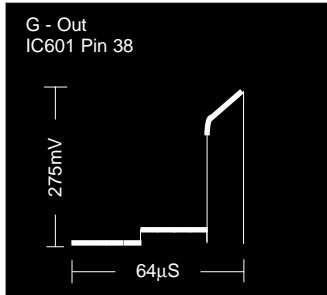
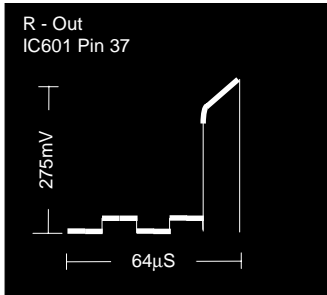
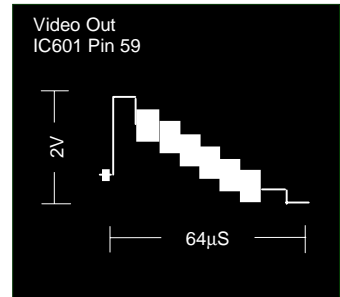
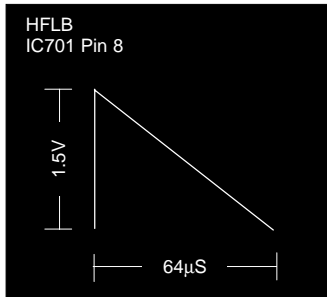
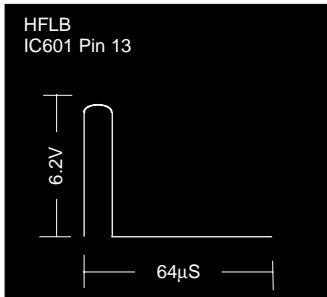
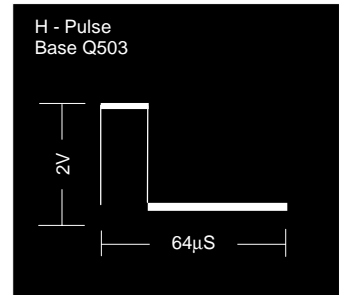
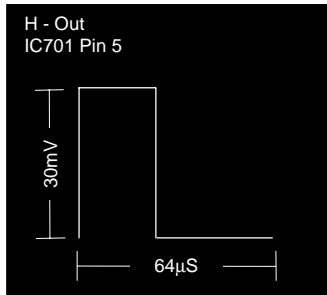
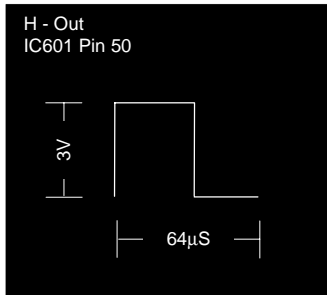
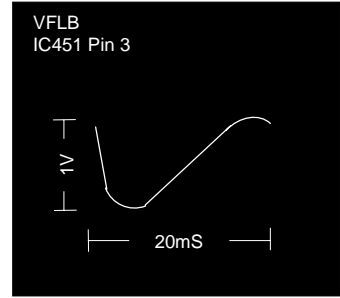
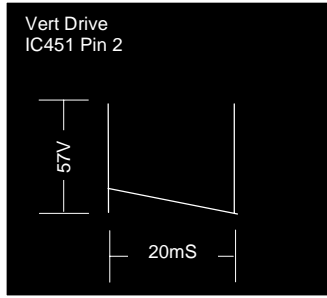
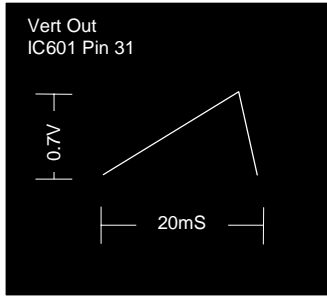

ALIGNMENT SETTINGS:

(The figures below are nominal and used for representative purposes only.)

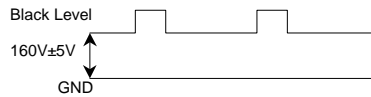
Alignment Function		Settings / Special features
Horizontal Position	H-Pos 061	Optimum setting.
Vertical Position	V-Pos 005	Optimum setting.
Horizontal Amplitude	H-Amp 055	Optimum setting.
Vert. Amplitude	V. Amp 054	Optimum setting.
EW-amplitude	E/W-Amp1 -128	Optimum setting.
EW-amplitude	E/W-Amp2 006	Optimum setting.
Trapezium-comp	Trapez-1 047	Optimum setting.
Trapezium-comp	Trapez-2 -128	Optimum setting.
Vertical Linearity	V-Lin 006	Optimum setting.
Vertical Symmetry	V-Sym 002	Optimum setting.
DVCO	DVCO -005	Receive a PAL Colour Bar Pattern. For DVCO alignment press " Blue " button, wait until the colours are changing slowly and press " STR ".
Cut-off DC	Cut-off 0171	To adjust Cutoff connect an oscilloscope to the blue cathode, adjust "cutoff" value using the " Yellow " and " Blue " buttons until the black level is $160V \pm 5V$ press " STR " to store the value. Remove the oscilloscope.
Ug2 Test	Ug2 055 O.K.	Select Ug2 adjustment and adjust the screen VR until the display shows " O.K. " 
Highlight Lowlight	High 0902 0777 0864 Low 0117 0132 0112	Optimum setting.
Sub-Brightness	Sub-Brightness 255	Optimum setting.

ABGLEICHTABELLE

(Die angegebenen Werte sind Mittelwerte und Können individuell nach oben oder unten nach dem korrekten Abgleich abweichen.)

Abgleichfunktion		Einstellung / Besondere Merkmale
Horizontale position	H-Pos 061	Optimale Einstellung.
Vertikale Position	V-Pos 005	Optimale Einstellung.
Horizontale Amplitude	H-Amp 055	Optimale Einstellung.
Vertikale Amplitude	V-Amp 054	Optimale Einstellung.
OW-amplitude	E/W-Amp1 -128	Optimale Einstellung.
OW-amplitude	E/W-Amp2 006	Optimale Einstellung.
Trapez-Kompensation	Trapez-1 047	Optimale Einstellung.
Trapez-Kompensation	Trapez-2 -128	Optimale Einstellung.
Vertikale linearität	V-Lin 006	Optimale Einstellung.
Vertikale Symmetrie	V-Sym 002	Optimale Einstellung.
DVCO	DVCO -005	Ein Farbbalken-Testbild empfangen. Zum Abgleich des Farboszillators (DVCO) die blau Taste drücken. Nachdem ein leichtes Flackern in den Farbbalken zum Stillstand gekommen ist, die STR -Taste drücken.
Cut-off	Cut-off 0171	Einen Oszillographen an die blaue Katode der Bildröhre anschliessen. Mit der gelben und blauen Taste den CUT-OFF Wert auf $160V \pm 5V$ abgleichen und mit der STR -Taste abspeichern. Den Oszillograph entfernen und den Ug2 Test aufrufen. Den Abgleichwert solange ändern, bis OK auf dem Bildschirm erscheint. Den Wert abspeichern.
Ug2 Test	Ug2 055 O.K.	
Highlight Lowlight	High 0902 0777 0864 Low 0117 0132 0112	Optimale Einstellung.
Sub-Brightness	Sub-Brightness 255	Optimale Einstellung.

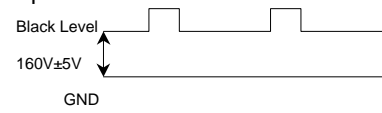

VIDEO BLOCK DIAGRAM

BILDSIGNAL BLOCKSCHEMA

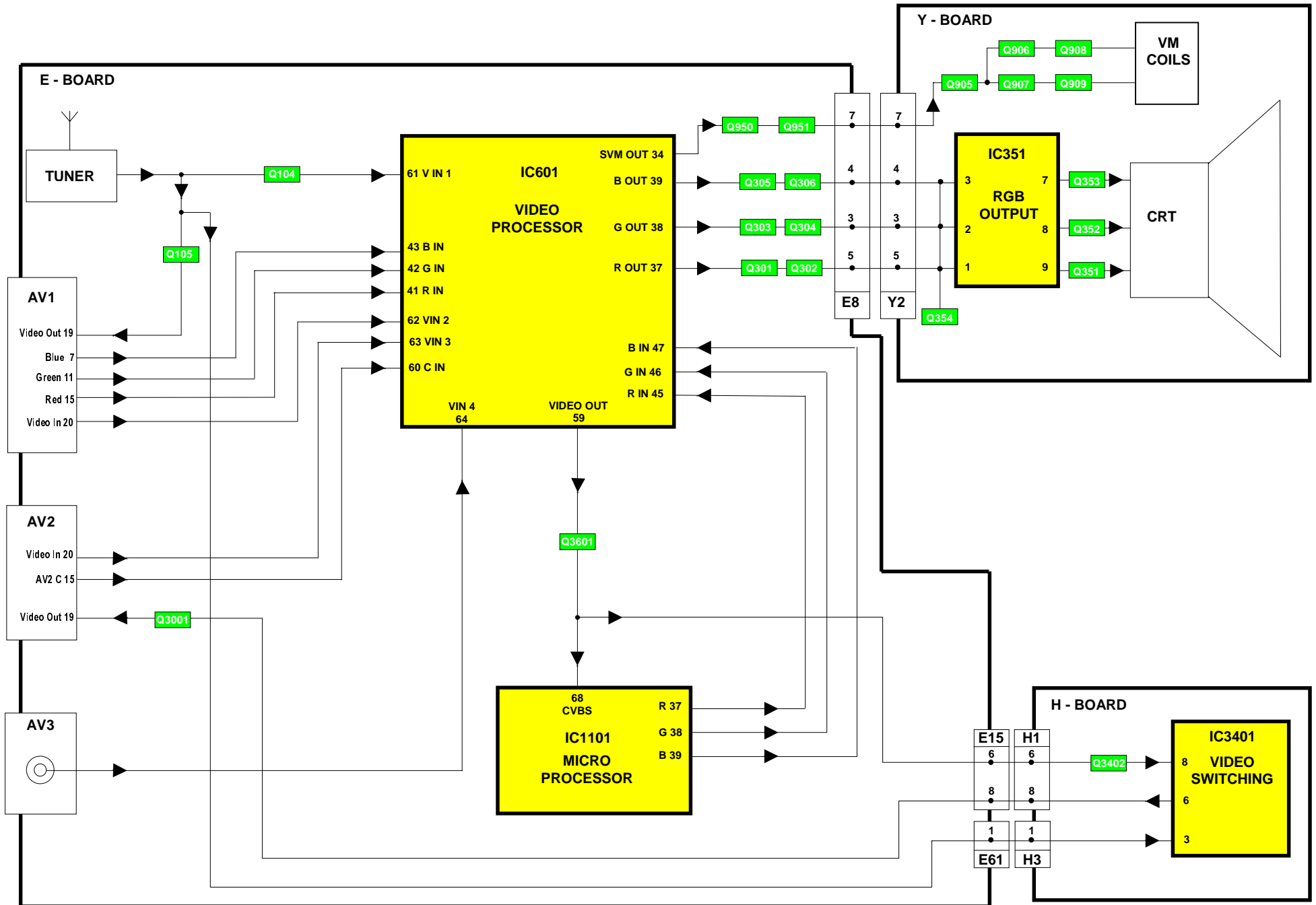

12

AUDIO BLOCK DIAGRAM

TONSIGNAL BLOCKSCHEMA

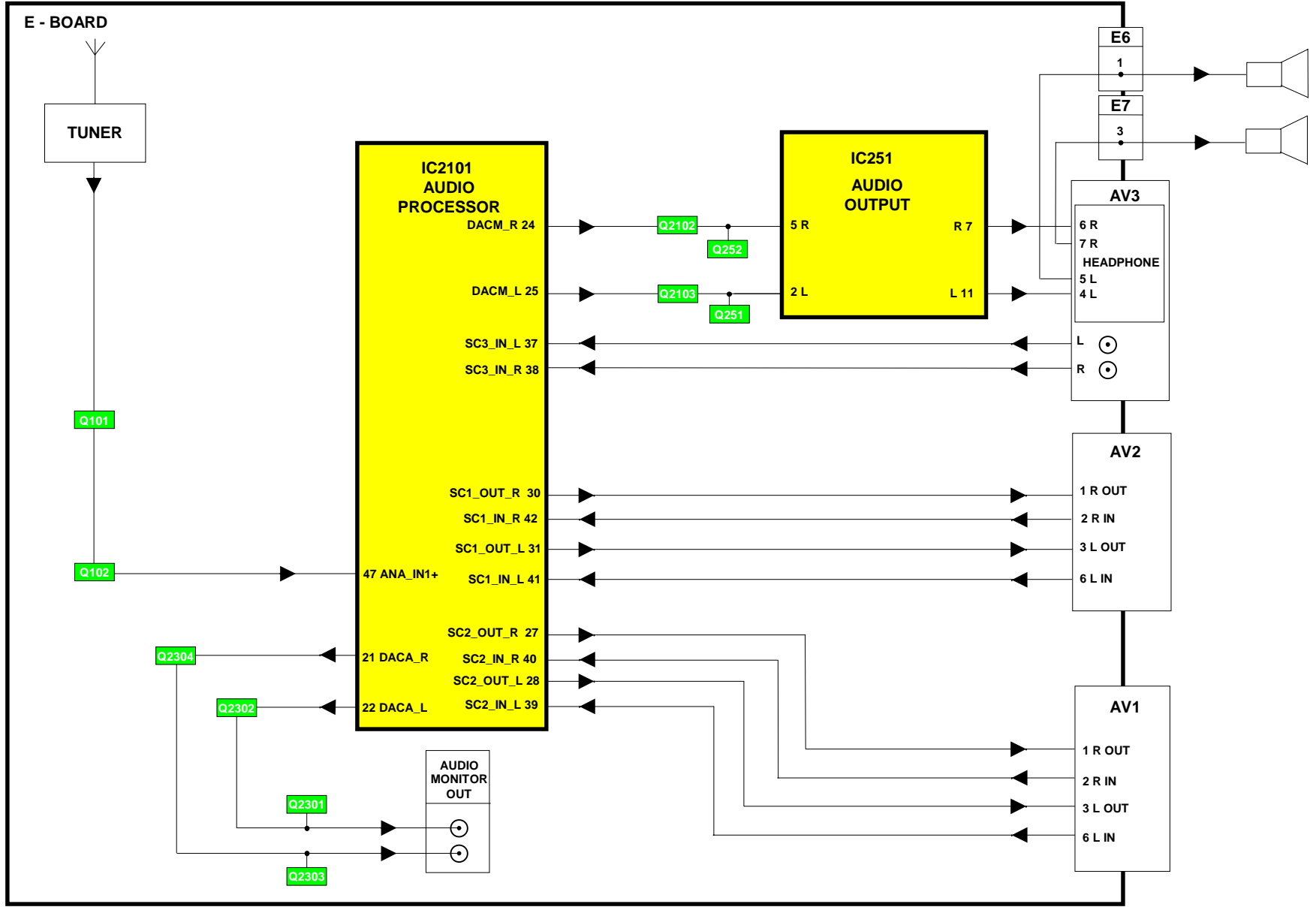

CONTROL BLOCK DIAGRAM

STROMVERSORGUNGS BLOCKSCHEMA

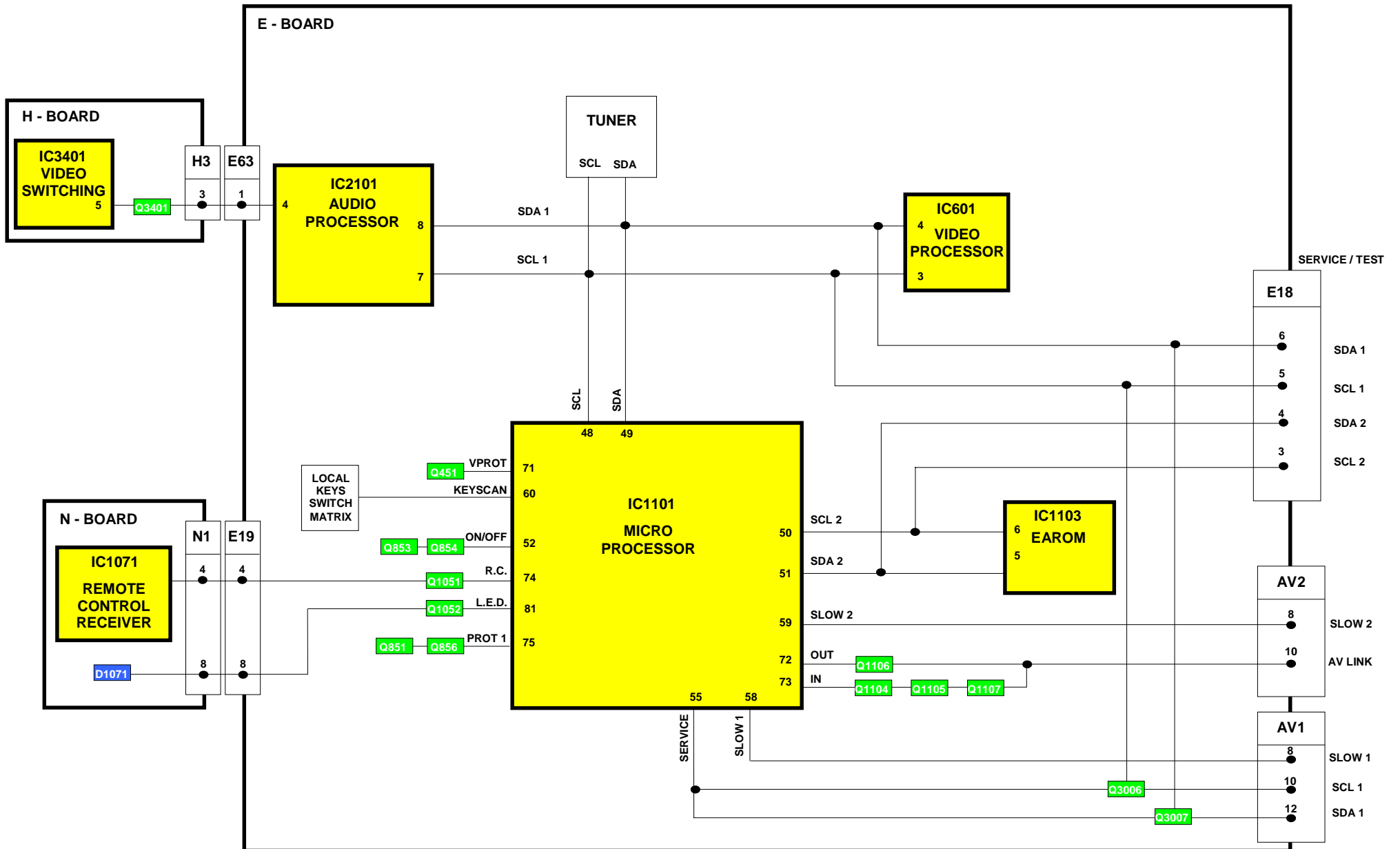

14

POWER SUPPLY BLOCK DIAGRAM

STROMVERSORGUNGS BLOCKSCHEMA

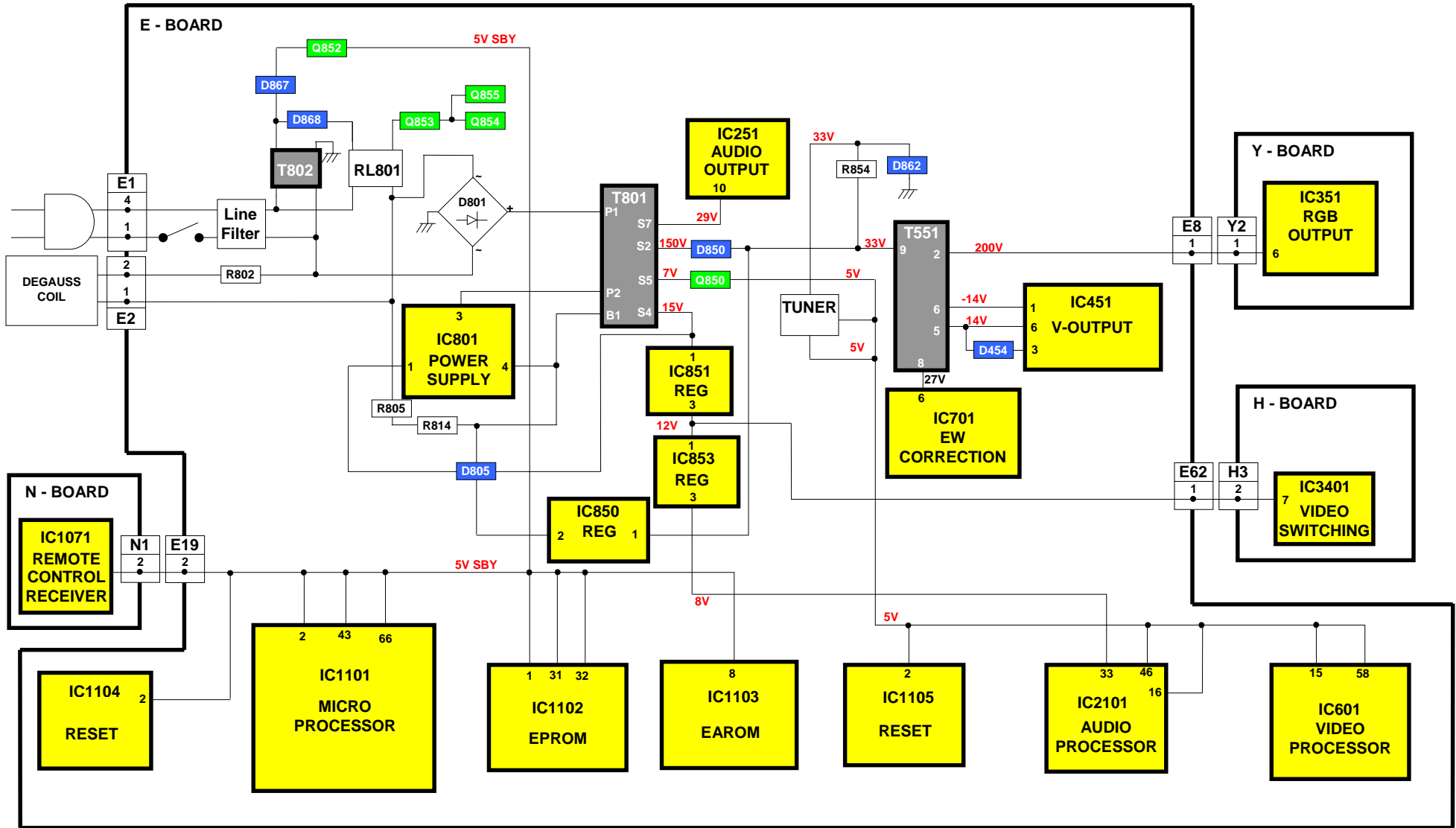

PARTS LOCATION

EXPLOSIONSZEICHNUNG

NOTE:

The numbers on the exploded view below refer to the mechanical section of the Replacement Parts List.

Anmerkung:

Die Nummer auf den mechanischen Teilen zeigt die Bezugsnummer der Ersatzteilliste an.

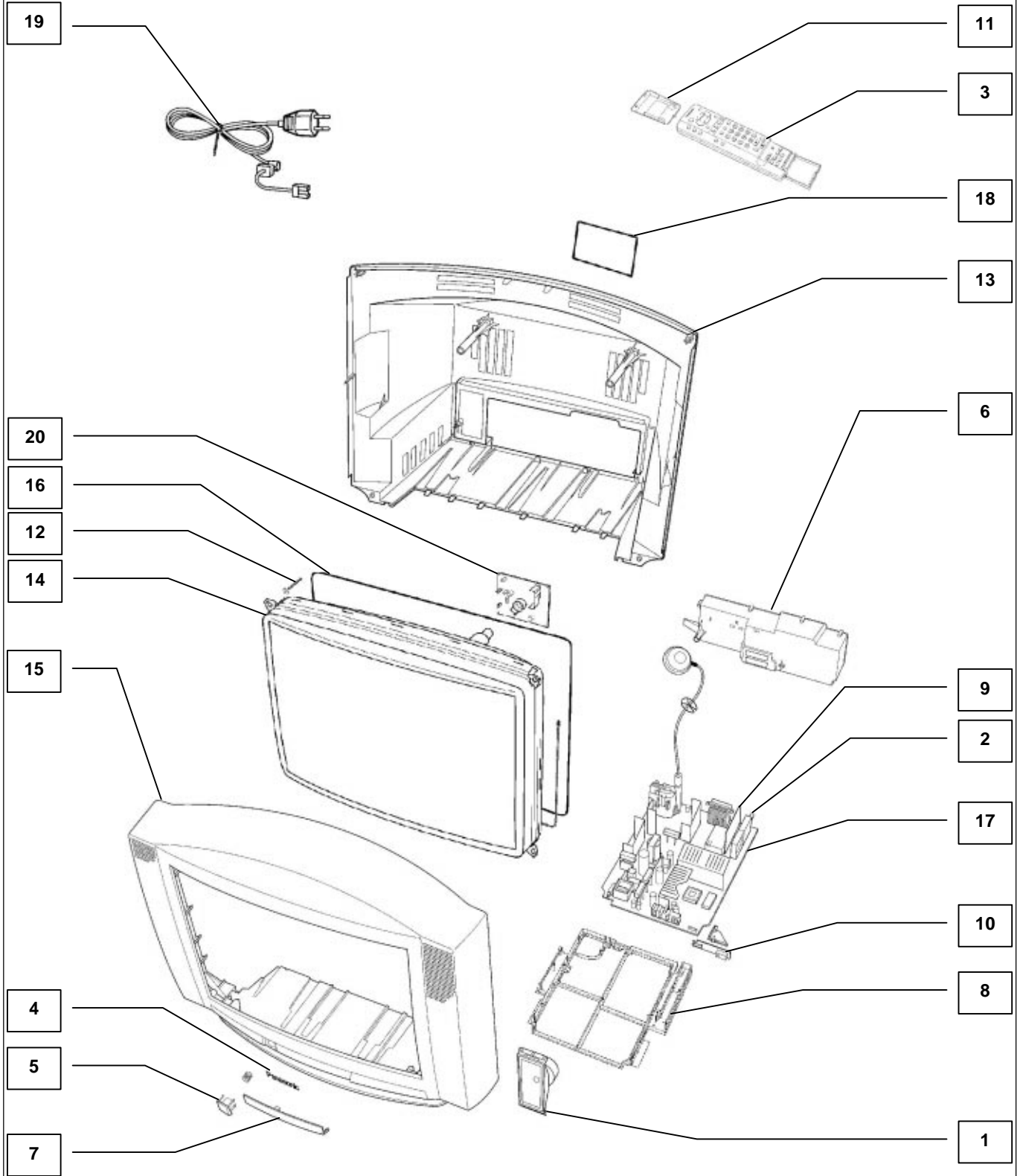

REPLACEMENT PARTS LIST









Important Safety Notice

Components Identified by  mark have special characteristics important for safety.
When replacing any of these components, use only manufacturers specified parts.
* In case of ordering these spare parts, please always add the complete Model-Type number to your order.

ERSATZTEILLISTE

Wichtiger Sicherheitshinweis

Teile, die mit einem Hinweis  gekennzeichnet sind wichtig für die Sicherheit. Sollte ein Auswechsellinien erforderlich sein, sind unbedingt Originalteile einzusetzen.
Bei der Bestellung von Ersatzteilen, die mit * gekennzeichnet sind, geben Sie bitte unbedingt die vollständige Typenbezeichnung mit an.

Cct Ref	Parts Number	Description
COMMON PARTS		
MECHANICAL PARTS		
1	EASG15S505A2	SPEAKER
2	ENG27507G	TUNER 
3	EUR511200	REMOTE CONTROL
4	TBM8E1728	PANASONIC BADGE
5	TBX8E050	POWER BUTTON
6	TKP8E1222	REAR AV COVER
7	TKP8E1223	DOOR LID
8	TMX8E020	CHASSIS FRAME
9	TNP8EH002AA	H P.C.B. 
10	TNP8EN016AA	N P.C.B. 
11	UR51EC904A	BATTERY COVER (REMOTE)
12	VP17005-32	CRT FIXING SCREW
MISCELLANEOUS COMPONENTS		
	31221212478	FIX CLIP
	832AG11D-ESL	I.C. SOCKET
	F9-4-220	RELAY
	PCS-084A-1	84 PIN SOCKET
	TBM8E1615	PRESET LABEL
	TBM8E1781	REAR AV LABEL
	TEK6940	LID CATCH
	TES8E015	POWER BUTTON SPRING
	TMW8E027	LED HOLDER
	UM-3DJ-2P	BATTERY PACK
	ZTUZAE550A	ANODE LEAD
RL801	TSE1885-1	RELAY 
R802	232266296706	THERMISTOR 
S351	0330550049	CRT SOCKET
INSTRUCTION BOOKS		
	TQB8E2468A	GERMAN 
	TQB8E2468B	DUTCH 
	TQB8E2468C	ITALIAN 
I.C.s		
IC251	LA4282	AUDIO OUTPUT
IC351	TDA6103Q-N3	R.G.B. AMPLIFIER
IC451	LA7845N	VERTICAL OUTPUT
IC601	VDP3108BPPB1	VIDEO PROCESSOR
IC701	TEA2031A	HORIZONTAL OUTPUT
IC801	STRF6654LF51	POWER SUPPLY
IC850	SE140N	ERROR AMPLIFIER
IC851	L78M12MRB	12V REGULATOR
IC853	AN78L08TA	8V REGULATOR
IC1071	RPM-637CBRL	LED RECEIVER
IC1101	SDA5450C48GE	TEXT MICRO
IC1102	27C2001F01AA	EPROM *

Cct Ref	Parts Number	Description
IC1104	MN1381-R(TA)	DIODE
IC1105	MN1381-T(TA)	DIODE
IC2101	MSP3400CPOC8	AUDIO PROCESSOR
IC3401	TEA2114	AV SWITCHING
FUSES		
F802	19181-3.15	FUSE 
F8021	EYF52BC	FUSE HOLDER
F8022	EYF52BC	FUSE HOLDER
DIODES		
D251	MA2180TP	DIODE
D253	MA700TA5	DIODE
D254	MA700TA5	DIODE
D354	1SR124-4AT82	DIODE
D355	1SR124-4AT82	DIODE
D356	1SR124-4AT82	DIODE
D357	MA165TA5	DIODE
D358	MA165TA5	DIODE
D359	MA165TA5	DIODE
D360	MTZJT-7715A	DIODE
D361	MA165TA5	DIODE
D362	MA165TA5	DIODE
D363	MA165TA5	DIODE
D364	MA165TA5	DIODE
D453	MA165TA5	DIODE
D454	ERA15-02V3	DIODE
D456	MTZJT-775.6C	DIODE
D457	MA165TA5	DIODE
D501	MA165TA5	DIODE
D502	1SR124-4AT82	DIODE
D511	MA4047	DIODE
D551	ERD07-15L7	DIODE
D552	RU3LFA1	DIODE
D553	1SR124-4AT82	DIODE
D554	1SR124-4AT82	DIODE
D556	MA165TA5	DIODE
D557	1SR124-4AT82	DIODE
D558	1SR124-4AT82	DIODE
D601	DAN217T146	DIODE
D603	DAN217T146	DIODE
D605	DAN212KT146	DIODE
D606	MA165TA5	DIODE
D607	MA4051	DIODE
D609	1SR124-4AT82	DIODE
D615	STZ6.2NT146	DIODE
D616	STZ6.2NT146	DIODE
D701	MA165TA5	DIODE
D702	MTZJT-775.1C	DIODE
D704	MA29TA5	DIODE
D705	MTZJT-775.6C	DIODE
D801	RBV4-08	DIODE
D803	1SR124-4AT82	DIODE
D804	1SR124-4AT82	DIODE

Cct Ref	Parts Number	Description
D805	TLP621GR-LF2	PHOTO COUPLER
D806	1SR124-4AT82	DIODE
D850	RU4BLF-L1	DIODE
D851	MTZJT776.2B	DIODE
D852	MA165TA5	DIODE
D853	MA2180BLFS	DIODE
D854	TVSRU2AMLFA5	DIODE
D855	FML22SLF610	DIODE
D856	RU4AMLF-M1	DIODE
D857	MTZJT-775.1C	DIODE
D858	MA165TA5	DIODE
D859	MA165TA5	DIODE
D861	MA165TA5	DIODE
D862	MTZJT-7736A	DIODE
D863	MA165TA5	DIODE
D865	MA165TA5	DIODE
D866	MA165TA5	DIODE
D867	EK06-V0	DIODE
D868	1N4150T-77	DIODE
D869	1N4150T-77	DIODE
D870	MA165TA5	DIODE
D871	1N4150T-77	DIODE
D873	MTZJT-775.6C	DIODE
D874	1SR124-4AT82	DIODE
D875	BZX79A75A26A	DIODE
D901	MA165TA5	DIODE
D902	MA165TA5	DIODE
D904	MA165TA5	DIODE
D905	MA165TA5	DIODE
D906	RLS72TE-11	DIODE
D1071	SLR56UR3FS	LED
D1072	MTZJT-778.2C	DIODE
D1101	MA165TA5	DIODE
D1102	MA165TA5	DIODE
D2101	MA723TA5	DIODE
D2102	MA723TA5	DIODE
D2103	MA723TA5	DIODE
D2104	MA723TA5	DIODE
D2105	MTZJT-778.2C	DIODE
D2303	MA723TA5	DIODE
D2304	MA723TA5	DIODE
D3101	MTZJT-778.2C	DIODE
D3102	MTZJT-778.2C	DIODE
TRANSISTORS		
Q101	BC847B	TRANSISTOR
Q102	BC847B	TRANSISTOR
Q104	BC847B	TRANSISTOR
Q105	BC847B	TRANSISTOR
Q251	2SD1328STX	TRANSISTOR
Q252	2SD1328STX	TRANSISTOR
Q301	BC847B	TRANSISTOR
Q302	FMY4T148	TRANSISTOR
Q303	BC847B	TRANSISTOR
Q304	FMY4T148	TRANSISTOR
Q305	BC847B	TRANSISTOR
Q306	FMY4T148	TRANSISTOR
Q351	2SA1767	TRANSISTOR
Q352	2SA1767	TRANSISTOR
Q353	2SA1767	TRANSISTOR
Q354	BC857B	TRANSISTOR
Q451	BC857B	TRANSISTOR
Q503	2SD2398-M2	TRANSISTOR
Q551	BU2508AXLB	TRANSISTOR
Q552	2SC1473-RN	TRANSISTOR
Q701	BC857B	TRANSISTOR
Q850	2SD1273PLB	TRANSISTOR

Cct Ref	Parts Number	Description
Q851	BC857B	TRANSISTOR
Q852	2SC1383-S	TRANSISTOR
Q853	BC847B	TRANSISTOR
Q854	BC847B	TRANSISTOR
Q855	BC847B	TRANSISTOR
Q856	BC847B	TRANSISTOR
Q857	2SA1018QTA	TRANSISTOR
Q905	BC847B	TRANSISTOR
Q906	BC847B	TRANSISTOR
Q907	BC857B	TRANSISTOR
Q908	2SA1535ARLB	TRANSISTOR
Q909	2SC3944ARLB	TRANSISTOR
Q950	BC847B	TRANSISTOR
Q951	FMY4T148	TRANSISTOR
Q1051	BC847B	TRANSISTOR
Q1052	BC847B	TRANSISTOR
Q1101	BC847B	TRANSISTOR
Q1104	BC847B	TRANSISTOR
Q1105	BC847B	TRANSISTOR
Q1106	BC847B	TRANSISTOR
Q1107	BC847B	TRANSISTOR
Q1108	BC847B	TRANSISTOR
Q2101	BC857B	TRANSISTOR
Q2102	BC857B	TRANSISTOR
Q2103	BC857B	TRANSISTOR
Q2301	BC847B	TRANSISTOR
Q2302	BC857B	TRANSISTOR
Q2303	BC847B	TRANSISTOR
Q2304	BC857B	TRANSISTOR
Q3001	BC847B	TRANSISTOR
Q3006	BC847B	TRANSISTOR
Q3007	BC847B	TRANSISTOR
Q3401	BC847B	TRANSISTOR
Q3402	BC847B	TRANSISTOR
Q3601	BC847B	TRANSISTOR
TRANSFORMERS		
T501	ETH19Y173AY	TRANSFORMER
T551	ZTFL94002A	F.B.T.
T801	ETS39AG1J7AD	TRANSFORMER
T802	ETP35KAN619U	TRANSFORMER
COILS		
L104	EXCELSA35T	COIL
L106	TLTACT100K	COIL
L107	TLTACT6R8K	COIL
L301	TLTACT4R7K	COIL
L302	TLTACT4R7K	COIL
L451	EXCELSA35T	COIL
L501	EXCELSA35V	COIL
L552	ELH5L4105	COIL
L553	ELC08D682E	COIL
L554	ELC18B102L	COIL
L601	TLTACT4R7K	COIL
L602	TLTACT4R7K	COIL
L603	TLTACT4R7K	COIL
L604	TLTACT4R7K	COIL
L606	TLTACT4R7K	COIL
L607	ELJFC2R2KF	COIL
L701	ELC10D822E	COIL
L850	EXCELSA35T	COIL
L851	EXCELSA35T	COIL
L852	ELEIN470KA	COIL
L853	EXCELSA35T	COIL
L854	EXCELSA35T	COIL
L855	EXCELSA35T	COIL
L856	EXCELSA39V	COIL
L901	EXCELSA24T	COIL

Cct Ref	Parts Number	Description
L902	EXCELSA24T	COIL
L1103	TLTACT100K	COIL
L1104	EXCELSA35T	COIL
L1105	ELJFC2R2KF	COIL
L2101	TLTACT100K	COIL
L2103	EXCELSA35T	COIL
L2104	TLTACT4R7K	COIL
L3001	ELEMV1R5MA	COIL
L3002	ELEMV1R5MA	COIL
L3003	ELEMV1R5MA	COIL
L3004	ELEMV1R5MA	COIL
L3005	ELEBR2R2KA	COIL
L3006	ELEBR2R2KA	COIL
L3007	TLTACT2R2K	COIL
L3101	ELEBT6R8KA	COIL
L3102	ELEBT6R8KA	COIL
L3401	ELESN2R2KA	COIL
L3402	ELESN2R2KA	COIL
FILTERS		
L804	ELF18N010A	LINE FILTER
CRYSTALS		
X601	4730007267	CRYSTAL
X1101	TAF10020	CRYSTAL
X2101	4730007158	CRYSTAL
RESISTORS		
C101	ERJ6GEY0R00	S.M.CARB 0.1W 5% 0 Ω
JSE12	ERJ6GEY0R00	S.M.CARB 0.1W 5% 0 Ω
JA54	ERJ6GEY0R00	S.M.CARB 0.1W 5% 0 Ω
JA40	ERJ6GEY0R00	S.M.CARB 0.1W 5% 0 Ω
JA44	ERJ6GEY0R00	S.M.CARB 0.1W 5% 0 Ω
JA45	ERJ6GEY0R00	S.M.CARB 0.1W 5% 0 Ω
JA38	ERJ6GEY0R00	S.M.CARB 0.1W 5% 0 Ω
JA47	ERJ6GEY0R00	S.M.CARB 0.1W 5% 0 Ω
JA37	ERJ6GEY0R00	S.M.CARB 0.1W 5% 0 Ω
JA48	ERJ6GEY0R00	S.M.CARB 0.1W 5% 0 Ω
JA49	ERJ6GEY0R00	S.M.CARB 0.1W 5% 0 Ω
JA52	ERJ6GEY0R00	S.M.CARB 0.1W 5% 0 Ω
JA39	ERJ6GEY0R00	S.M.CARB 0.1W 5% 0 Ω
JA55	ERJ6GEY0R00	S.M.CARB 0.1W 5% 0 Ω
JA57	ERJ6GEY0R00	S.M.CARB 0.1W 5% 0 Ω
JA58	ERJ6GEY0R00	S.M.CARB 0.1W 5% 0 Ω
JA60	ERJ6GEY0R00	S.M.CARB 0.1W 5% 0 Ω
JSE10	ERJ6GEY0R00	S.M.CARB 0.1W 5% 0 Ω
JSE18	ERJ6GEY0R00	S.M.CARB 0.1W 5% 0 Ω
JSE4	ERJ6GEY0R00	S.M.CARB 0.1W 5% 0 Ω
JSE5	ERJ6GEY0R00	S.M.CARB 0.1W 5% 0 Ω
JSH001	ERJ6GEY0R00	S.M.CARB 0.1W 5% 0 Ω
JA36	ERJ6GEY0R00	S.M.CARB 0.1W 5% 0 Ω
JSE3	ERJ6GEY0R00	S.M.CARB 0.1W 5% 0 Ω
JA9	ERJ6GEY0R00	S.M.CARB 0.1W 5% 0 Ω
JA16	ERJ6GEY0R00	S.M.CARB 0.1W 5% 0 Ω
JA27	ERJ6GEY0R00	S.M.CARB 0.1W 5% 0 Ω
JA26	ERJ6GEY0R00	S.M.CARB 0.1W 5% 0 Ω
JA25	ERJ6GEY0R00	S.M.CARB 0.1W 5% 0 Ω
JA22	ERJ6GEY0R00	S.M.CARB 0.1W 5% 0 Ω
JA28	ERJ6GEY0R00	S.M.CARB 0.1W 5% 0 Ω
JA2	ERJ6GEY0R00	S.M.CARB 0.1W 5% 0 Ω
JA15	ERJ6GEY0R00	S.M.CARB 0.1W 5% 0 Ω
JA14	ERJ6GEY0R00	S.M.CARB 0.1W 5% 0 Ω
JA3	ERJ6GEY0R00	S.M.CARB 0.1W 5% 0 Ω
JA11	ERJ6GEY0R00	S.M.CARB 0.1W 5% 0 Ω
JA10	ERJ6GEY0R00	S.M.CARB 0.1W 5% 0 Ω
JA1	ERJ6GEY0R00	S.M.CARB 0.1W 5% 0 Ω
JA13	ERJ6GEY0R00	S.M.CARB 0.1W 5% 0 Ω
JA21	ERJ8GEY0R00	S.M.CARB .125W 5% 0 Ω

Cct Ref	Parts Number	Description
JA31	ERJ8GEY0R00	S.M.CARB .125W 5% 0 Ω
JSE26	ERJ8GEY0R00	S.M.CARB .125W 5% 0 Ω
JA46	ERJ8GEY0R00	S.M.CARB .125W 5% 0 Ω
JA23	ERJ8GEY0R00	S.M.CARB .125W 5% 0 Ω
JA1	ERJ8GEY0R00	S.M.CARB .125W 5% 0 Ω
JA59	ERJ8GEY0R00	S.M.CARB .125W 5% 0 Ω
JA50	ERJ8GEY0R00	S.M.CARB .125W 5% 0 Ω
JA2	ERJ8GEY0R00	S.M.CARB .125W 5% 0 Ω
JA56	ERJ8GEY0R00	S.M.CARB .125W 5% 0 Ω
JA51	ERJ8GEY0R00	S.M.CARB .125W 5% 0 Ω
JA8	ERJ8GEY0R00	S.M.CARB .125W 5% 0 Ω
JA5	ERJ8GEY0R00	S.M.CARB .125W 5% 0 Ω
JA32	ERJ8GEY0R00	S.M.CARB .125W 5% 0 Ω
JA33	ERJ8GEY0R00	S.M.CARB .125W 5% 0 Ω
JA34	ERJ8GEY0R00	S.M.CARB .125W 5% 0 Ω
JA35	ERJ8GEY0R00	S.M.CARB .125W 5% 0 Ω
JA43	ERJ8GEY0R00	S.M.CARB .125W 5% 0 Ω
JA30	ERJ8GEY0R00	S.M.CARB .125W 5% 0 Ω
JA29	ERJ8GEY0R00	S.M.CARB .125W 5% 0 Ω
R101	ERJ6GEY0R00	S.M.CARB 0.1W 5% 0 Ω
R102	ERJ6GEYJ103	S.M.CARB 0.1W 5% 10K Ω
R103	ERJ6GEYJ222	S.M.CARB 0.1W 5% 2K2 Ω
R104	ERJ6GEYJ332	S.M.CARB 0.1W 5% 3K3 Ω
R105	ERJ6GEYJ101	S.M.CARB 0.1W 5% 100 Ω
R106	ERJ6GEYJ681	S.M.CARB 0.1W 5% 680 Ω
R107	ERJ6GEYJ102	S.M.CARB 0.1W 5% 1K Ω
R111	ERJ6GEY0R00	S.M.CARB 0.1W 5% 0 Ω
R112	ERJ6GEYJ101	S.M.CARB 0.1W 5% 100 Ω
R113	ERJ6GEYJ223	S.M.CARB 0.1W 5% 22K Ω
R114	ERJ6GEYJ331	S.M.CARB 0.1W 5% 330 Ω
R115	ERJ6GEYJ331	S.M.CARB 0.1W 5% 330 Ω
R116	ERJ6GEYJ562	S.M.CARB 0.1W 5% 5K6 Ω
R117	ERJ6GEYJ222	S.M.CARB 0.1W 5% 2K2 Ω
R118	ERJ6GEYJ102	S.M.CARB 0.1W 5% 1K Ω
R120	ERJ6GEYJ332	S.M.CARB 0.1W 5% 3K3 Ω
R121	ERJ6GEYJ471	S.M.CARB 0.1W 5% 470 Ω
R251	ERJ6GEYJ101	S.M.CARB 0.1W 5% 100 Ω
R252	ERJ6GEYJ272	S.M.CARB 0.1W 5% 2K7 Ω
R253	ERJ6GEYJ103	S.M.CARB 0.1W 5% 10K Ω
R254	ERJ6GEYJ101	S.M.CARB 0.1W 5% 100 Ω
R255	ERJ6GEYJ103	S.M.CARB 0.1W 5% 10K Ω
R256	ERJ6GEYJ471	S.M.CARB 0.1W 5% 470 Ω
R257	ERJ6GEYJ100	S.M.CARB 0.1W 5% 10 Ω
R258	ERJ6GEYJ272	S.M.CARB 0.1W 5% 2K7 Ω
R259	ERJ6GEYJ100	S.M.CARB 0.1W 5% 10 Ω
R260	ERJ6GEYJ103	S.M.CARB 0.1W 5% 10K Ω
R261	ERJ6GEYJ471	S.M.CARB 0.1W 5% 470 Ω
R262	ERJ6GEYJ103	S.M.CARB 0.1W 5% 10K Ω
R265	ERD25TJ2R2	CARBON 0.25W 5% 2R2 Ω
R266	ERD25TJ2R2	CARBON 0.25W 5% 2R2 Ω
R267	ERF7ZK4R7	WOUND 7W 10% 4R7 Ω
R271	ERJ6GEYJ103	S.M.CARB 0.1W 5% 10K Ω
R272	ERF7ZK4R7	WOUND 7W 10% 4R7 Ω
R301	ERJ6GEYJ391	S.M.CARB 0.1W 5% 390 Ω
R302	ERJ6GEYJ102	S.M.CARB 0.1W 5% 1K Ω
R303	ERJ6GEYJ750	S.M.CARB 0.1W 5% 75 Ω
R304	ERJ6GEYJ331	S.M.CARB 0.1W 5% 330 Ω
R305	ERJ6GEYJ391	S.M.CARB 0.1W 5% 390 Ω
R306	ERJ6GEYJ102	S.M.CARB 0.1W 5% 1K Ω
R307	ERJ6GEYJ750	S.M.CARB 0.1W 5% 75 Ω
R308	ERJ6GEYJ331	S.M.CARB 0.1W 5% 330 Ω
R309	ERJ6GEYJ391	S.M.CARB 0.1W 5% 390 Ω
R310	ERJ6GEYJ102	S.M.CARB 0.1W 5% 1K Ω
R311	ERJ6GEYJ750	S.M.CARB 0.1W 5% 75 Ω
R312	ERJ6GEYJ331	S.M.CARB 0.1W 5% 330 Ω
R351	ERJ6GEYJ302	S.M.CARB 0.1W 5% 3K Ω

Cct Ref	Parts Number	Description				
R352	ERJ6GEYJ302	S.M.CARB	0.1W	5%	3K	☐
R353	ERJ6GEYJ302	S.M.CARB	0.1W	5%	3K	☐
R354	ERJ6GEYJ102	S.M.CARB	0.1W	5%	1K	☐
R355	ERJ6GEYJ102	S.M.CARB	0.1W	5%	1K	☐
R356	ERJ6GEYJ102	S.M.CARB	0.1W	5%	1K	☐
R357	ERDS1TJ104	CARBON	0.5W	5%	100K	☐
R358	ERDS1TJ104	CARBON	0.5W	5%	100K	☐
R359	ERDS1TJ104	CARBON	0.5W	5%	100K	☐
R363	ERD25TJ103	CARBON	0.25W	5%	10K	☐
R364	ERD25TJ103	CARBON	0.25W	5%	10K	☐
R365	ERD25TJ103	CARBON	0.25W	5%	10K	☐
R366	ERDS1TJ152	CARBON	0.5W	5%	1K5	☐
R367	ERDS1TJ152	CARBON	0.5W	5%	1K5	☐
R368	ERDS1TJ152	CARBON	0.5W	5%	1K5	☐
R369	ERD25TJ472	CARBON	0.25W	5%	4K7	☐
R370	ERJ6GEYJ102	S.M.CARB	0.1W	5%	1K	☐
R372	ERQ12AJ121	FUSIBLE	0.5W	5%	120	☐ ⚠
R373	ERJ6GEYJ220	S.M.CARB	0.1W	5%	22	☐
R374	ERD25TJ274	CARBON	0.25W	5%	270K	☐
R375	ERJ6GEYJ684	S.M.CARB	0.1W	5%	680K	☐
R376	ERJ6GEYJ183	S.M.CARB	0.1W	5%	18K	☐
R377	ERQ1ABJP5R1	METAL	0.5W	5%	5R1	☐ ⚠
R381	ERJ6GEYJ473	S.M.CARB	0.1W	5%	47K	☐
R451	ERJ6GEYJ223	S.M.CARB	0.1W	5%	22K	☐
R452	ERJ6GEY0R00	S.M.CARB	0.1W	5%	0	☐
R453	ERJ6GEY0R00	S.M.CARB	0.1W	5%	0	☐
R454	ERJ6GEYJ752	S.M.CARB	0.1W	5%	7K5	☐
R455	ERJ6GEYJ222	S.M.CARB	0.1W	5%	2K2	☐
R456	ERJ6GEYJ104	S.M.CARB	0.1W	5%	100K	☐
R457	ERJ6GEYJ223	S.M.CARB	0.1W	5%	22K	☐
R458	ERD25TJ1R5	CARBON	0.25W	5%	1R5	☐
R459	ERJ6GEYJ101	S.M.CARB	0.1W	5%	100	☐
R460	ERDS1TJ331	CARBON	0.5W	5%	330	☐
R461	ERW2PK1R2	WOUND	2W	10%	1R2	☐ ⚠
R463	ERD25TJ222	CARBON	0.25W	5%	2K2	☐
R464	ERJ6GEYJ182	S.M.CARB	0.1W	5%	1K8	☐
R465	ERJ6GEYJ681	S.M.CARB	0.1W	5%	680	☐
R502	ERJ6GEYJ560	S.M.CARB	0.1W	5%	56	☐
R506	ERD25TJ560	CARBON	0.25W	5%	56	☐
R507	ERG1FJ271P	METAL	1W	5%	270	☐ ⚠
R509	ERDS1TJ152	CARBON	0.5W	5%	1K5	☐
R510	ERDS1TJ152	CARBON	0.5W	5%	1K5	☐
R553	ERG1SJ152	METAL	1W	5%	1K5	☐
R554	ERG1SJ101	METAL	1W	5%	100	☐
R555	ERQ12HKR33	METAL	0.5W	5%	R33	☐ ⚠
R558	ERDS1TJ124	CARBON	0.5W	5%	120K	☐
R559	ERQ12HKR33	METAL	0.5W	5%	R33	☐ ⚠
R560	ERJ6GEYJ274	S.M.CARB	0.1W	5%	270K	☐
R561	ERJ6GEYJ273	S.M.CARB	0.1W	5%	27K	☐
R563	ERJ6GEYJ474	S.M.CARB	0.1W	5%	470K	☐
R564	ERJ6GEYJ623	S.M.CARB	0.1W	5%	62K	☐
R566	ERJ6GEYJ563	S.M.CARB	0.1W	5%	56K	☐
R567	ERF7ZK1R0	WOUND	7W	10%	1	☐ ⚠
R601	ERJ6GEYJ101	S.M.CARB	0.1W	5%	100	☐
R602	ERJ6GEYJ821	S.M.CARB	0.1W	5%	820	☐
R603	ERJ8GEYJ103	S.M.CARB	.125W	5%	10K	☐
R604	ERJ6GEYJ101	S.M.CARB	0.1W	5%	100	☐
R605	ERD25TJ331	CARBON	0.25W	5%	330	☐
R606	ERD25TJ331	CARBON	0.25W	5%	330	☐
R607	ERJ6GEYJ821	S.M.CARB	0.1W	5%	820	☐
R608	ERJ6GEYJ271	S.M.CARB	0.1W	5%	270	☐
R609	ERJ6GEYJ122	S.M.CARB	0.1W	5%	1K2	☐
R610	ERJ6GEY0R00	S.M.CARB	0.1W	5%	0	☐
R611	ERJ6GEYJ103	S.M.CARB	0.1W	5%	10K	☐
R612	ERJ6GEYJ101	S.M.CARB	0.1W	5%	100	☐
R613	ERJ6GEYJ751	S.M.CARB	0.1W	5%	750	☐

Cct Ref	Parts Number	Description				
R622	ERJ6GEY0R00	S.M.CARB	0.1W	5%	0	☐
R636	ERJ6GEYJ750	S.M.CARB	0.1W	5%	75	☐
R645	ERJ6GEYJ103	S.M.CARB	0.1W	5%	10K	☐
R647	ERJ6GEYJ472	S.M.CARB	0.1W	5%	4K7	☐
R648	ERJ6GEY0R00	S.M.CARB	0.1W	5%	0	☐
R650	ERJ6GEYJ750	S.M.CARB	0.1W	5%	75	☐
R651	ERJ6GEYJ750	S.M.CARB	0.1W	5%	75	☐
R652	ERJ6GEYJ102	S.M.CARB	0.1W	5%	1K	☐
R654	ERJ6GEYJ622	S.M.CARB	0.1W	5%	6K2	☐
R655	ERJ6GEYJ103	S.M.CARB	0.1W	5%	10K	☐
R658	ERJ6GEYJ223	S.M.CARB	0.1W	5%	22K	☐
R659	ERJ6GEY0R00	S.M.CARB	0.1W	5%	0	☐
R660	ERJ6GEY0R00	S.M.CARB	0.1W	5%	0	☐
R701	ERQ12AJ101	FUSIBLE	0.5W	5%	100	☐ ⚠
R702	ERQ12HJ8R2	FUSIBLE	0.5W	5%	8R2	☐ ⚠
R703	ERG2FJ821	METAL	2W	5%	820	☐ ⚠
R704	ERJ6GEYJ563	S.M.CARB	0.1W	5%	56K	☐
R705	ERJ6GEYJ104	S.M.CARB	0.1W	5%	100K	☐
R706	ERJ6GEYJ103	S.M.CARB	0.1W	5%	10K	☐
R707	ERJ6GEYJ391	S.M.CARB	0.1W	5%	390	☐
R708	ERJ6GEYJ393	S.M.CARB	0.1W	5%	39K	☐
R709	ERJ6GEYJ393	S.M.CARB	0.1W	5%	39K	☐
R710	ERJ6GEYJ273	S.M.CARB	0.1W	5%	27K	☐
R711	ERG1SJ101	METAL	1W	5%	100	☐
R712	ERJ6GEYJ102	S.M.CARB	0.1W	5%	1K	☐
R803	ERC12ZGK335D	SOLID	0.5W	10%	3M3	☐
R805	ERD25TJ473	CARBON	0.25W	5%	47K	☐
R806	ERD25TJ100	CARBON	0.25W	5%	10	☐
R807	ERD25TJ332	CARBON	0.25W	5%	3K3	☐
R809	ERD25TJ681	CARBON	0.25W	5%	680	☐
R810	ERW2PKR33	WOUND	2W	20%	R33	☐ ⚠
R811	ERW2PKR33	WOUND	2W	20%	R33	☐ ⚠
R812	ERD75TAJ825	CARBON	0.75W	5%	8M2	☐ ⚠
R813	ERF7ZK2R7	WOUND	7W	20%	2R7	☐ ⚠
R814	ERD25TJ473	CARBON	0.25W	5%	47K	☐
R815	ERD25TJ222	CARBON	0.25W	5%	2K2	☐
R850	ERD25TJ122	CARBON	0.25W	5%	1K2	☐
R852	ERJ6GEY0R00	S.M.CARB	0.1W	5%	0	☐
R853	ERJ6GEYJ102	S.M.CARB	0.1W	5%	1K	☐
R854	ERG2FJ223	METAL	2W	5%	22K	☐ ⚠
R855	ERJ6GEYJ752	S.M.CARB	0.1W	5%	7K5	☐
R857	ERJ6GEYJ752	S.M.CARB	0.1W	5%	7K5	☐
R858	ERJ6GEYJ752	S.M.CARB	0.1W	5%	7K5	☐
R859	ERJ6GEYJ753	S.M.CARB	0.1W	5%	75K	☐
R860	ERQ1CJP2R2	FUSIBLE	1W	10%	2R2	☐ ⚠
R861	ERD25TJ221	CARBON	0.25W	5%	220	☐
R862	ERD25TJ272	CARBON	0.25W	5%	2K7	☐
R863	ERDS1TJ560	CARBON	0.5W	5%	56	☐
R864	ERDS1TJ680	CARBON	0.5W	5%	68	☐
R865	ERJ6GEY0R00	S.M.CARB	0.1W	5%	0	☐
R867	ERJ6GEYJ103	S.M.CARB	0.1W	5%	10K	☐
R868	ERJ6GEYJ223	S.M.CARB	0.1W	5%	22K	☐
R869	ERJ6GEY0R00	S.M.CARB	0.1W	5%	0	☐
R870	ERJ6GEYJ272	S.M.CARB	0.1W	5%	2K7	☐
R871	ERJ6GEYJ153	S.M.CARB	0.1W	5%	15K	☐
R872	ERG1SJ183	METAL	1W	5%	18K	☐
R873	ERG1SJ223	METAL	1W	5%	22K	☐
R874	ERD25TJ104	CARBON	0.25W	5%	100K	☐
R876	ERJ6GEYJ103	S.M.CARB	0.1W	5%	10K	☐
R877	ERW2PKR56	WOUND	2W	10%	R56	☐ ⚠
R878	ERJ6GEYJ473	S.M.CARB	0.1W	5%	47K	☐
R913	ERJ6GEYJ473	S.M.CARB	0.1W	5%	47K	☐
R914	ERJ6GEYJ822	S.M.CARB	0.1W	5%	8K2	☐
R915	ERJ6GEYJ152	S.M.CARB	0.1W	5%	1K5	☐
R916	ERJ6GEYJ391	S.M.CARB	0.1W	5%	390	☐
R919	ERQ14AJW390	FUSIBLE	0.25W	5%	39	☐ ⚠

Cct Ref	Parts Number	Description					
R920	ERQ14AJW390	FUSIBLE	0.25W	5%	39	🔒	⚠️
R921	ERD25TJ471	CARBON	0.25W	5%	470	🔒	
R922	ERD25TJ393	CARBON	0.25W	5%	39K	🔒	
R923	ERD25TJ393	CARBON	0.25W	5%	39K	🔒	
R924	ERDS1FJ390	CARBON	0.5W	5%	39	🔒	⚠️
R925	ERJ6GEY0R00	S.M.CARB	0.1W	5%	0	🔒	
R926	ERJ6GEY0R00	S.M.CARB	0.1W	5%	0	🔒	
R927	ERD25TJ471	CARBON	0.25W	5%	470	🔒	
R928	ERD25TJ5R6	CARBON	0.25W	5%	5R6	🔒	
R929	ERDS1FJ471	CARBON	0.5W	5%	470	🔒	⚠️
R930	ERD25TJ5R6	CARBON	0.25W	5%	5R6	🔒	
R931	ERDS1FJ390	CARBON	0.5W	5%	39	🔒	⚠️
R935	ERQ14AJW3R9	FUSIBLE	0.25W	5%	3R9	🔒	⚠️
R936	ERQ1CJP331	FUSIBLE	1W	5%	330	🔒	⚠️
R951	ERJ6GEYJ391	S.M.CARB	0.1W	5%	390	🔒	
R952	ERJ6GEYJ102	S.M.CARB	0.1W	5%	1K	🔒	
R953	ERJ6GEYJ750	S.M.CARB	0.1W	5%	75	🔒	
R954	ERJ6GEYJ391	S.M.CARB	0.1W	5%	390	🔒	
R1051	ERJ6GEYJ102	S.M.CARB	0.1W	5%	1K	🔒	
R1052	ERJ6GEYJ271	S.M.CARB	0.1W	5%	270	🔒	
R1053	ERJ6GEYJ103	S.M.CARB	0.1W	5%	10K	🔒	
R1054	ERJ6GEY0R00	S.M.CARB	0.1W	5%	0	🔒	
R1071	ERJ6GEYJ750	S.M.CARB	0.1W	5%	75	🔒	
R1101	ERJ6GEYJ101	S.M.CARB	0.1W	5%	100	🔒	
R1102	ERJ6GEYJ102	S.M.CARB	0.1W	5%	1K	🔒	
R1103	ERJ6GEYJ331	S.M.CARB	0.1W	5%	330	🔒	
R1104	ERJ6GEYJ331	S.M.CARB	0.1W	5%	330	🔒	
R1105	ERJ6GEYJ101	S.M.CARB	0.1W	5%	100	🔒	
R1106	ERJ6GEYJ104	S.M.CARB	0.1W	5%	100K	🔒	
R1107	ERJ6GEYJ104	S.M.CARB	0.1W	5%	100K	🔒	
R1108	ERJ6GEYJ102	S.M.CARB	0.1W	5%	1K	🔒	
R1109	ERJ6GEYJ472	S.M.CARB	0.1W	5%	4K7	🔒	
R1110	ERJ6GEYJ472	S.M.CARB	0.1W	5%	4K7	🔒	
R1111	ERJ6GEYJ473	S.M.CARB	0.1W	5%	47K	🔒	
R1112	ERJ6GEYJ473	S.M.CARB	0.1W	5%	47K	🔒	
R1113	ERJ6GEYJ101	S.M.CARB	0.1W	5%	100	🔒	
R1115	ERJ6GEYJ471	S.M.CARB	0.1W	5%	470	🔒	
R1116	ERJ6GEYJ101	S.M.CARB	0.1W	5%	100	🔒	
R1117	ERJ6GEYJ101	S.M.CARB	0.1W	5%	100	🔒	
R1118	ERJ6GEYJ472	S.M.CARB	0.1W	5%	4K7	🔒	
R1119	ERJ6GEYJ472	S.M.CARB	0.1W	5%	4K7	🔒	
R1120	ERJ6GEYJ101	S.M.CARB	0.1W	5%	100	🔒	
R1121	ERJ6GEYJ101	S.M.CARB	0.1W	5%	100	🔒	
R1123	ERJ6GEYJ101	S.M.CARB	0.1W	5%	100	🔒	
R1125	ERJ6GEYJ472	S.M.CARB	0.1W	5%	4K7	🔒	
R1126	ERJ6GEYJ101	S.M.CARB	0.1W	5%	100	🔒	
R1127	ERJ6GEYJ101	S.M.CARB	0.1W	5%	100	🔒	
R1128	ERJ6GEYJ682	S.M.CARB	0.1W	5%	6K8	🔒	
R1129	ERJ6GEYJ682	S.M.CARB	0.1W	5%	6K8	🔒	
R1130	ERJ6GEYJ103	S.M.CARB	0.1W	5%	10K	🔒	
R1131	ERJ6GEYJ103	S.M.CARB	0.1W	5%	10K	🔒	
R1132	ERJ6GEYJ101	S.M.CARB	0.1W	5%	100	🔒	
R1133	ERJ6GEYJ273	S.M.CARB	0.1W	5%	27K	🔒	
R1136	ERJ6GEYJ823	S.M.CARB	0.1W	5%	82K	🔒	
R1137	ERJ6GEY0R00	S.M.CARB	0.1W	5%	0	🔒	
R1138	ERJ6GEYJ474	S.M.CARB	0.1W	5%	470K	🔒	
R1139	ERJ6GEYJ471	S.M.CARB	0.1W	5%	470	🔒	
R1140	ERJ6GEYJ471	S.M.CARB	0.1W	5%	470	🔒	
R1141	ERJ6GEYJ471	S.M.CARB	0.1W	5%	470	🔒	
R1145	ERJ6GEYJ101	S.M.CARB	0.1W	5%	100	🔒	
R1146	ERJ6GEYJ101	S.M.CARB	0.1W	5%	100	🔒	
R1147	ERJ6GEYJ101	S.M.CARB	0.1W	5%	100	🔒	
R1148	ERJ6GEYJ101	S.M.CARB	0.1W	5%	100	🔒	
R1149	ERJ6GEYJ223	S.M.CARB	0.1W	5%	22K	🔒	
R1151	ERJ6GEYJ101	S.M.CARB	0.1W	5%	100	🔒	
R1152	ERJ6GEYJ101	S.M.CARB	0.1W	5%	100	🔒	

Cct Ref	Parts Number	Description					
R1154	ERJ6GEYJ101	S.M.CARB	0.1W	5%	100	🔒	
R1155	ERJ6GEYJ101	S.M.CARB	0.1W	5%	100	🔒	
R1156	ERJ6GEYJ101	S.M.CARB	0.1W	5%	100	🔒	
R1157	ERJ6GEYJ103	S.M.CARB	0.1W	5%	10K	🔒	
R1158	ERJ6GEY0R00	S.M.CARB	0.1W	5%	0	🔒	
R1159	ERJ6GEY0R00	S.M.CARB	0.1W	5%	0	🔒	
R1160	ERJ6GEYJ223	S.M.CARB	0.1W	5%	22K	🔒	
R1161	ERJ6GEYJ103	S.M.CARB	0.1W	5%	10K	🔒	
R1162	ERJ6GEYJ222	S.M.CARB	0.1W	5%	2K2	🔒	
R1163	ERJ6GEYJ222	S.M.CARB	0.1W	5%	2K2	🔒	
R1164	ERJ6GEYJ332	S.M.CARB	0.1W	5%	3K3	🔒	
R1165	ERJ6GEYJ512	S.M.CARB	0.1W	5%	5K1	🔒	
R1166	ERJ6GEYJ912	S.M.CARB	0.1W	5%	9K1	🔒	
R1167	ERJ6GEYJ100	S.M.CARB	0.1W	5%	10	🔒	
R1168	ERJ6GEYJ473	S.M.CARB	0.1W	5%	47K	🔒	
R1169	ERJ6GEYJ472	S.M.CARB	0.1W	5%	4K7	🔒	
R1170	ERJ6GEYJ273	S.M.CARB	0.1W	5%	27K	🔒	
R1171	ERJ6GEYJ224	S.M.CARB	0.1W	5%	220K	🔒	
R1172	ERJ6GEYJ223	S.M.CARB	0.1W	5%	22K	🔒	
R1173	ERJ6GEYJ104	S.M.CARB	0.1W	5%	100K	🔒	
R1174	ERJ6GEYJ221	S.M.CARB	0.1W	5%	220	🔒	
R1175	ERJ6GEYJ225	S.M.CARB	0.1W	5%	2M2	🔒	
R1176	ERJ6GEYJ100	S.M.CARB	0.1W	5%	10	🔒	
R2101	ERJ6GEYJ103	S.M.CARB	0.1W	5%	10K	🔒	
R2102	ERJ6GEYJ101	S.M.CARB	0.1W	5%	100	🔒	
R2103	ERJ6GEYJ101	S.M.CARB	0.1W	5%	100	🔒	
R2104	ERJ6GEYJ101	S.M.CARB	0.1W	5%	100	🔒	
R2105	ERJ6GEYJ101	S.M.CARB	0.1W	5%	100	🔒	
R2106	ERJ6GEYJ101	S.M.CARB	0.1W	5%	100	🔒	
R2107	ERJ6GEYJ101	S.M.CARB	0.1W	5%	100	🔒	
R2108	ERJ6GEYJ101	S.M.CARB	0.1W	5%	100	🔒	
R2109	ERJ6GEYJ183	S.M.CARB	0.1W	5%	18K	🔒	
R2110	ERJ6GEY0R00	S.M.CARB	0.1W	5%	0	🔒	
R2111	ERJ6GEYJ221	S.M.CARB	0.1W	5%	220	🔒	
R2112	ERJ6GEYJ102	S.M.CARB	0.1W	5%	1K	🔒	
R2113	ERJ6GEYJ562	S.M.CARB	0.1W	5%	5K6	🔒	
R2114	ERJ6GEYJ101	S.M.CARB	0.1W	5%	100	🔒	
R2115	ERJ6GEYJ222	S.M.CARB	0.1W	5%	2K2	🔒	
R2116	ERJ6GEYJ101	S.M.CARB	0.1W	5%	100	🔒	
R2117	ERJ6GEYJ101	S.M.CARB	0.1W	5%	100	🔒	
R2118	ERJ6GEYJ222	S.M.CARB	0.1W	5%	2K2	🔒	
R2119	ERJ6GEYJ101	S.M.CARB	0.1W	5%	100	🔒	
R2120	ERJ6GEYJ222	S.M.CARB	0.1W	5%	2K2	🔒	
R2302	ERJ6GEYJ104	S.M.CARB	0.1W	5%	100K	🔒	
R2303	ERJ6GEYJ101	S.M.CARB	0.1W	5%	100	🔒	
R2304	ERJ6GEYJ471	S.M.CARB	0.1W	5%	470	🔒	
R2305	ERJ6GEYJ102	S.M.CARB	0.1W	5%	1K	🔒	
R2306	ERJ6GEYJ103	S.M.CARB	0.1W	5%	10K	🔒	
R2308	ERJ6GEYJ104	S.M.CARB	0.1W	5%	100K	🔒	
R2309	ERJ6GEYJ101	S.M.CARB	0.1W	5%	100	🔒	
R2310	ERJ6GEYJ471	S.M.CARB	0.1W	5%	470	🔒	
R2311	ERJ6GEYJ102	S.M.CARB	0.1W	5%	1K	🔒	
R2312	ERJ6GEYJ103	S.M.CARB	0.1W	5%	10K	🔒	
R3001	ERJ6GEYJ101	S.M.CARB	0.1W	5%	100	🔒	
R3002	ERJ6GEYJ471	S.M.CARB	0.1W	5%	470	🔒	
R3003	ERJ6GEYJ101	S.M.CARB	0.1W	5%	100	🔒	
R3004	ERJ6GEYJ153	S.M.CARB	0.1W	5%	15K	🔒	
R3005	ERJ6GEYJ101	S.M.CARB	0.1W	5%	100	🔒	
R3006	ERJ6GEYJ471	S.M.CARB	0.1W	5%	470	🔒	
R3007	ERJ6GEYJ101	S.M.CARB	0.1W	5%	100	🔒	
R3008	ERJ6GEYJ153	S.M.CARB	0.1W	5%	15K	🔒	
R3009	ERJ6GEYJ750	S.M.CARB	0.1W	5%	75	🔒	
R3010	ERJ6GEYJ750	S.M.CARB	0.1W	5%	75	🔒	
R3011	ERJ6GEYJ101	S.M.CARB	0.1W	5%	100	🔒	
R3012	ERJ6GEYJ750	S.M.CARB	0.1W	5%	75	🔒	
R3013	ERJ6GEYJ101	S.M.CARB	0.1W	5%	100	🔒	

Cct Ref	Parts Number	Description				
R3014	ERJ6GEYJ471	S.M.CARB	0.1W	5%	470	Ω
R3015	ERJ6GEYJ101	S.M.CARB	0.1W	5%	100	Ω
R3016	ERJ6GEYJ153	S.M.CARB	0.1W	5%	15K	Ω
R3017	ERJ6GEYJ101	S.M.CARB	0.1W	5%	100	Ω
R3018	ERJ6GEYJ471	S.M.CARB	0.1W	5%	470	Ω
R3019	ERJ6GEYJ101	S.M.CARB	0.1W	5%	100	Ω
R3020	ERJ6GEYJ153	S.M.CARB	0.1W	5%	15K	Ω
R3021	ERJ6GEYJ750	S.M.CARB	0.1W	5%	75	Ω
R3022	ERJ6GEYJ102	S.M.CARB	0.1W	5%	1K	Ω
R3023	ERJ6GEYJ123	S.M.CARB	0.1W	5%	12K	Ω
R3024	ERJ6GEYJ472	S.M.CARB	0.1W	5%	4K7	Ω
R3025	ERJ6GEYJ750	S.M.CARB	0.1W	5%	75	Ω
R3026	ERJ6GEYJ750	S.M.CARB	0.1W	5%	75	Ω
R3044	ERJ6GEYJ750	S.M.CARB	0.1W	5%	75	Ω
R3046	ERJ6GEYJ101	S.M.CARB	0.1W	5%	100	Ω
R3047	ERJ6GEYJ101	S.M.CARB	0.1W	5%	100	Ω
R3048	ERJ6GEYJ103	S.M.CARB	0.1W	5%	10K	Ω
R3049	ERJ6GEYJ101	S.M.CARB	0.1W	5%	100	Ω
R3050	ERJ6GEYJ103	S.M.CARB	0.1W	5%	10K	Ω
R3057	ERJ6GEYJ750	S.M.CARB	0.1W	5%	75	Ω
R3101	ERDS1TJ151	CARBON	0.5W	5%	150	Ω
R3102	ERDS1TJ151	CARBON	0.5W	5%	150	Ω
R3103	ERG2FJ221	METAL	2W	5%	220	Ω
R3104	ERG2FJ221	METAL	2W	5%	220	Ω
R3105	ERJ6GEYJ101	S.M.CARB	0.1W	5%	100	Ω
R3106	ERJ6GEYJ101	S.M.CARB	0.1W	5%	100	Ω
R3107	ERJ6GEYJ153	S.M.CARB	0.1W	5%	15K	Ω
R3108	ERJ6GEYJ153	S.M.CARB	0.1W	5%	15K	Ω
R3402	ERJ6GEYJ750	S.M.CARB	0.1W	5%	75	Ω
R3403	ERJ6GEYJ101	S.M.CARB	0.1W	5%	100	Ω
R3404	ERJ6GEYJ242	S.M.CARB	0.1W	5%	2K4	Ω
R3405	ERJ6GEYJ104	S.M.CARB	0.1W	5%	100K	Ω
R3406	ERJ6GEYJ301	S.M.CARB	0.1W	5%	300	Ω
R3407	ERJ6GEYJ123	S.M.CARB	0.1W	5%	12K	Ω
R3408	ERJ6GEYJ472	S.M.CARB	0.1W	5%	4K7	Ω
R3409	ERJ6GEYJ750	S.M.CARB	0.1W	5%	75	Ω
R3601	ERJ6GEYJ101	S.M.CARB	0.1W	5%	100	Ω
R3602	ERJ6GEYJ101	S.M.CARB	0.1W	5%	100	Ω
R3603	ERJ6GEYJ101	S.M.CARB	0.1W	5%	100	Ω
R3604	ERJ6GEYJ101	S.M.CARB	0.1W	5%	100	Ω
R3605	ERJ6GEYJ101	S.M.CARB	0.1W	5%	100	Ω
R3606	ERJ6GEYJ101	S.M.CARB	0.1W	5%	100	Ω
R3607	ERJ6GEYJ472	S.M.CARB	0.1W	5%	4K7	Ω
R3608	ERJ6GEYJ752	S.M.CARB	0.1W	5%	7K5	Ω
R3609	ERJ6GEY0R00	S.M.CARB	0.1W	5%	0	Ω
R3610	ERJ6GEYJ102	S.M.CARB	0.1W	5%	1K	Ω
CAPACITORS						
C102	ECUV1H103ZFX	S.M. CAP	50V		10nF	
C103	ECJ2VF1H104Z	ELECT	350V		100nF	
C106	ECUV1H560JCX	S.M. CAP	50V		56pF	
C107	ECJ2VF1H104Z	ELECT	350V		100nF	
C108	ECA1CM470GB	ELECT	16V		47μF	
C109	ECUV1H102JCX	S.M. CAP	50V		1nF	
C110	ECUV1H103ZFX	S.M. CAP	50V		10nF	
C111	ECA1HMR33GB	ELECT	50V		10nF	
C117	ECUV1H103ZFX	S.M. CAP	50V		10nF	
C118	ECJ2VF1H104Z	ELECT	350V		100nF	
C119	ECA1CM221GB	ELECT	16V		220μF	
C120	ECA1CM221GB	ELECT	16V		220μF	
C121	ECUV1H561KXB	S.M. CAP	50V		560pF	
C122	ECUV1H102KXB	S.M. CAP	50V		1nF	
C123	ECUV1H102KXB	S.M. CAP	50V		1nF	
C124	ECUV1H220JCX	S.M. CAP	50V		22pF	
C125	ECUV1H100DCX	S.M. CAP	50V		10pF	
C251	ECA1EM330B	ELECT	25V		33μF	
C252	ECUV1H223KXB	S.M. CAP	50V		22nF	

Cct Ref	Parts Number	Description				
C253	ECA1HM4R7GB	ELECT	50V		4.7μF	
C254	ECQM1H684J	FILM	50V		4.7μF	
C255	ECA1EM101GB	ELECT	25V		100μF	
C256	ECUV1H223KXB	S.M. CAP	50V		22nF	
C257	ECA1HM4R7GB	ELECT	50V		4.7μF	
C258	ECA1EM330B	ELECT	25V		33μF	
C259	ECQM1H684J	FILM	50V		33μF	
C260	ECA1VM102GB	ELECT	35V		1nF	
C261	ECA1VM102GB	ELECT	35V		1nF	
C262	ECQM1H394J	FILM	50V		390nF	
C263	ECA1HM010GB	ELECT	50V		1μF	
C264	ECA1HHG222E	ELECT	50V		1μF	
C265	ECQM1H394J	FILM	50V		390nF	
C266	ECA1HM010GB	ELECT	50V		1μF	
C267	ECJ2VB1H104K	ELECT	350V		100nF	
C268	ECJ2VB1H104K	ELECT	350V		100nF	
C270	ECJ2VB1H104K	ELECT	350V		100nF	
C301	ECJ2VB1C104K	ELECT	350V		100nF	
C302	ECJ2VB1C104K	ELECT	350V		100nF	
C303	ECJ2VB1C104K	ELECT	350V		100nF	
C304	ECA1CM100GB	ELECT	16V		10μF	
C354	ECQM2104KZ	FILM	250V		100nF	
C355	ECUV1H471JCX	S.M. CAP	50V		470pF	
C356	ECUV1H471JCX	S.M. CAP	50V		470pF	
C357	ECUV1H471JCX	S.M. CAP	50V		470pF	
C358	ECQM1H224J	FILM	50V		220nF	
C360	ECKC3D152J	CERAMIC	2KV		1.5nF	⚠
C361	ECA1HMR47GB	ELECT	50V		1.5nF	
C363	ECA1VM471GB	ELECT	35V		470μF	
C364	ECUV1H103ZFX	S.M. CAP	50V		10nF	
C366	ECA1CM100GB	ELECT	16V		10μF	
C451	ECUV1H102JX	S.M. CAP	50V		10μF	
C453	ECUV1H152KXB	S.M. CAP	50V		10μF	
C454	ECUV1H223KBM	S.M. CAP	50V		10μF	
C455	ECEA1HKA010	ELECT	50V		1μF	
C456	ECA1HHG221B	ELECT	50V		220μF	
C458	ECQB1222JF3	FILM	100V		2.2nF	
C459	222236516154	FILM	160V		2.2nF	
C461	ECCR2H270J	CERAMIC	500V		27pF	
C508	ECQV1H105JZ	FILM	50V		1μF	
C509	ECEA1HU101	ELECT	50V		100μF	
C511	ECQM2683JZ	FILM	250V		68nF	
C552	ECWH15H102J	FILM	1500V		1nF	
C554	ECWF2H514J	FILM	500V		1nF	⚠
C555	ECWH15H103J	FILM	1500V		10nF	
C556	ECQM4333JC	FILM	400V		33nF	
C557	ECKC2H471J	CERAMIC	500V		470pF	⚠
C558	ECA1HHG471E	ELECT	50V		470μF	
C559	ECWF2H684J	FILM	500V		470μF	⚠
C560	ECA2GHG2R2B	ELECT	400V		470μF	
C561	ECA1EHG102B	ELECT	25V		470μF	
C562	ECKC2H101J	CERAMIC	500V		100pF	⚠
C563	ECA2EHG220B	ELECT	250V		20μF	
C564	ECEA2AU2R2	ELECT	100V		20μF	
C565	ECQP1H273J	FILM	100V		20μF	
C566	ECKC2H471J	CERAMIC	500V		470pF	⚠
C567	ECA1EHG102B	ELECT	25V		470pF	
C568	ECKC2H471J	CERAMIC	500V		470pF	⚠
C569	ECKC2H102J	CERAMIC	500V		1nF	⚠
C601	ECUV1H104KXB	S.M. CAP	50V		1nF	
C602	ECA1HM101GB	ELECT	50V		100μF	
C603	ECUV1H102JCX	S.M. CAP	50V		1nF	
C604	ECUV1H223ZFX	S.M. CAP	50V		22nF	
C605	ECA1HM101GB	ELECT	50V		100μF	
C606	ECA1HM3R3GB	ELECT	50V		3.3μF	
C607	ECJ2VF1H104Z	ELECT	350V		100nF	

Cct Ref	Parts Number	Description			
C608	ECUV1H153KBX	S.M. CAP	50V	15nF	
C609	ECUV1H153KBX	S.M. CAP	50V	15nF	
C610	ECUV1H153KBX	S.M. CAP	50V	15nF	
C611	ECUV1H153KBX	S.M. CAP	50V	15nF	
C612	ECUV1H153KBX	S.M. CAP	50V	15nF	
C613	ECUV1H153KBX	S.M. CAP	50V	15nF	
C614	ECUV1H050CCX	S.M. CAP	50V	50pF	
C615	ECUV1H050CCX	S.M. CAP	50V	50pF	
C616	ECA1CM100GB	ELECT	16V	10µF	
C617	ECUV1H223KBX	S.M. CAP	50V	22nF	
C618	ECA1CM221GB	ELECT	16V	220µF	
C619	ECJ2VB1H473K	ELECT	350V	47nF	
C620	ECA1HM101GB	ELECT	50V	100µF	
C621	ECJ2VB1C104K	ELECT	350V	100nF	
C622	ECUV1H102JCX	S.M. CAP	50V	1nF	
C623	ECUV1H102JCX	S.M. CAP	50V	1nF	
C624	ECJ3VB1C474K	ELECT	3.5KV	470nF	
C625	ECJ3VB1C474K	ELECT	3.5KV	470nF	
C626	ECJ3VB1C474K	ELECT	3.5KV	470nF	
C627	ECJ3VB1C474K	ELECT	3.5KV	470nF	
C628	ECA1CM100GB	ELECT	16V	10µF	
C629	ECUV1H104KBX	S.M. CAP	50V	10µF	
C631	ECUV1H683ZFX	S.M. CAP	50V	68nF	
C632	ECUV1H270JCX	S.M. CAP	50V	27pF	
C633	ECUV1H271JCX	S.M. CAP	50V	270pF	
C634	ECUV1H271JCX	S.M. CAP	50V	270pF	
C635	ECUV1H180JCX	S.M. CAP	50V	18pF	
C636	ECUV1H271JCX	S.M. CAP	50V	270pF	
C637	ECUV1H101JCX	S.M. CAP	50V	100pF	
C638	ECUV1H471JCX	S.M. CAP	50V	470pF	
C639	ECUV1H332KBM	S.M. CAP	50V	470pF	
C701	ECA1HHG101B	ELECT	50V	100µF	
C702	ECUV1H103KBX	S.M. CAP	50V	10nF	
C703	ECEA1HGE100	ELECT	50V	10µF	
C704	ECQB1H223K	FILM	50V	22nF	
C705	ECQB1H222J	FILM	50V	2.2nF	
C804	ECQE2A474MWB	FILM	100V	470nF	
C806	ECKWNA101MBC	CERAMIC	400V	100µF	
C807	ECKC2H472J	CERAMIC	500V	4.7nF	⚠
C808	ECKC2H472J	CERAMIC	500V	4.7nF	⚠
C809	ECKC2H472J	CERAMIC	500V	4.7nF	⚠
C810	ECKC2H472J	CERAMIC	500V	4.7nF	⚠
C811	ECOS2GG181NG	ELECT	400V	180µF	⚠
C814	ECKC3D102J	CERAMIC	2KV	1nF	⚠
C815	ECKC1H471J	CERAMIC	50V	470pF	
C816	ECA1EM101GB	ELECT	25V	100µF	
C817	ECQE6104K	FILM	600V	100nF	⚠
C818	ECKWNA332MEC	CERAMIC	250V	3.3nF	
C819	ECQB1H152K	FILM	50V	1.5nF	
C850	ECKC3D471JB	CERAMIC	2KV	470pF	⚠
C851	ECA2CM221E	ELECT	160V	220µF	
C852	ECA2CHG101E	ELECT	160V	100µF	
C853	ECKC2H471J	CERAMIC	500V	470pF	⚠
C854	ECA1EM102GB	ELECT	25V	100µF	
C855	ECKC2H471J	CERAMIC	500V	470pF	⚠
C856	ECA1AHG222B	ELECT	10V	470pF	
C857	ECKC2H471J	CERAMIC	500V	470pF	⚠
C858	ECEA1HGE102	ELECT	50V	470pF	
C859	ECJ2VF1H104Z	ELECT	350V	100nF	
C860	ECA1HM101GB	ELECT	50V	100µF	
C862	ECJ2VF1H104Z	ELECT	350V	100nF	
C863	ECA1HM101GB	ELECT	50V	100µF	
C866	ECJ2VF1H104Z	ELECT	350V	100nF	
C867	ECA1CM100GB	ELECT	16V	10µF	
C868	ECA1CM100GB	ELECT	16V	10µF	
C869	ECA1EM101GB	ELECT	25V	100µF	

Cct Ref	Parts Number	Description			
C870	ECA1EM471GB	ELECT	25V	470µF	
C871	ECA1CM102B	ELECT	16V	470µF	
C872	ECA1CM471GB	ELECT	16V	470µF	
C873	ECA1CM100GB	ELECT	16V	10µF	
C875	ECA2CM4R7B	ELECT	160V	10µF	
C876	ECA1AHG471E	ELECT	10V	470pF	
C902	ECA1VM101GB	ELECT	35V	100µF	
C903	ECUV1H472KBX	S.M. CAP	50V	4.7nF	
C904	ECUV1H472KBX	S.M. CAP	50V	4.7nF	
C906	ECUV1H471KBX	S.M. CAP	50V	470pF	
C908	ECUV1H151JCX	S.M. CAP	50V	150pF	
C909	ECKC2H472J	CERAMIC	500V	4.7nF	⚠
C910	ECKC2H472J	CERAMIC	500V	4.7nF	⚠
C911	ECUV1H151JCX	S.M. CAP	50V	150pF	
C912	ECEA2CU100	ELECT	160V	10µF	
C913	ECA1HM101GB	ELECT	50V	100µF	
C914	ECA1HM101GB	ELECT	50V	100µF	
C916	ECA2CHG100B	ELECT	160V	10µF	
C950	ECJ2VB1C104K	ELECT	350V	100nF	
C1071	ECUV1H331JCX	S.M. CAP	50V	330pF	
C1072	ECUV1H103KBX	S.M. CAP	50V	10nF	
C1073	ECA1HM101GB	ELECT	50V	100µF	
C1101	ECJ2VF1H104Z	ELECT	350V	100nF	
C1102	ECA0JM101G	ELECT	6.3V	100µF	
C1103	ECUV1H330JCX	S.M. CAP	50V	33pF	
C1104	ECUV1H330JCX	S.M. CAP	50V	33pF	
C1105	ECUV1H101JCX	S.M. CAP	50V	100pF	
C1108	ECUV1H333KBX	S.M. CAP	50V	33nF	
C1111	ECA1CM100GB	ELECT	16V	10µF	
C1112	ECUV1H103KBX	S.M. CAP	50V	10nF	
C1115	ECJ3VB1C474K	ELECT	3.5KV	470nF	
C1116	ECUV1H472KBX	S.M. CAP	50V	4.7nF	
C1117	ECJ2VF1H104Z	ELECT	350V	100nF	
C1118	ECUV1H103KBX	S.M. CAP	50V	10nF	
C1119	ECUV1H221JCX	S.M. CAP	50V	220pF	
C1120	ECJ2VF1H104Z	ELECT	350V	100nF	
C1121	ECUV1H221JCX	S.M. CAP	50V	220pF	
C1123	ECUV1H101JCX	S.M. CAP	50V	100pF	
C1124	ECUV1H101JCX	S.M. CAP	50V	100pF	
C1125	ECUV1H101JCX	S.M. CAP	50V	100pF	
C1126	ECUV1H101JCX	S.M. CAP	50V	100pF	
C1127	ECUV1H221JCX	S.M. CAP	50V	220pF	
C1128	ECUV1H223KBX	S.M. CAP	50V	22nF	
C2101	ECUV1H102JCX	S.M. CAP	50V	1nF	
C2102	ECUV1H102JCX	S.M. CAP	50V	1nF	
C2103	ECUV1H102JCX	S.M. CAP	50V	1nF	
C2104	ECUV1H102JCX	S.M. CAP	50V	1nF	
C2105	ECUV1H102JCX	S.M. CAP	50V	1nF	
C2106	ECUV1H102JCX	S.M. CAP	50V	1nF	
C2107	ECUV1H102JCX	S.M. CAP	50V	1nF	
C2108	ECUV1H102JCX	S.M. CAP	50V	1nF	
C2109	ECUV1H102JCX	S.M. CAP	50V	1nF	
C2110	ECUV1H102JCX	S.M. CAP	50V	1nF	
C2111	ECA1CM100GB	ELECT	16V	10µF	
C2112	ECA1CM100GB	ELECT	16V	10µF	
C2113	ECA1HM3R3GB	ELECT	50V	3.3µF	
C2114	ECJ2VF1H104Z	ELECT	350V	100nF	
C2115	ECUV1H221JCX	S.M. CAP	50V	220pF	
C2116	ECUV1H221JCX	S.M. CAP	50V	220pF	
C2117	ECUV1H221JCX	S.M. CAP	50V	220pF	
C2118	ECUV1H221JCX	S.M. CAP	50V	220pF	
C2119	ECUV1H221JCX	S.M. CAP	50V	220pF	
C2120	ECUV1H221JCX	S.M. CAP	50V	220pF	
C2121	ECA1CM100GB	ELECT	16V	10µF	
C2122	ECJ2VF1H104Z	ELECT	350V	100nF	
C2123	ECUV1H221JCX	S.M. CAP	50V	220pF	

Cct Ref	Parts Number	Description			
C2124	ECUV1H070DTX	S.M. CAP	50V	70pF	
C2125	ECUV1H470JCX	S.M. CAP	50V	47pF	
C2126	ECUV1H070DTX	S.M. CAP	50V	70pF	
C2127	ECUV1H010CCX	S.M. CAP	50V	1pF	
C2128	ECUV1H010CCX	S.M. CAP	50V	1pF	
C2129	ECA1CM102B	ELECT	16V	1pF	
C2130	ECA1CM331B	ELECT	16V	330µF	
C2131	ECUV1H103ZFX	S.M. CAP	50V	10nF	
C2132	ECUV1H103ZFX	S.M. CAP	50V	10nF	
C2134	ECUV1H103ZFX	S.M. CAP	50V	10nF	
C2135	ECA1HM101GB	ELECT	50V	100µF	
C2136	ECJ2VF1H104Z	ELECT	350V	100nF	
C2137	ECA1CM100GB	ELECT	16V	10µF	
C2138	ECUV1H471KBX	S.M. CAP	50V	470pF	
C2139	ECUV1H221JCX	S.M. CAP	50V	220pF	
C2140	ECA1HM101GB	ELECT	50V	100µF	
C2141	ECUV1H152JCX	S.M. CAP	50V	1.5pF	
C2301	ECUV1H222JCX	S.M. CAP	50V	2.2nF	
C2302	ECA1CM470GB	ELECT	16V	47µF	
C2303	ECUV1H222JCX	S.M. CAP	50V	2.2nF	
C2304	ECA1CM470GB	ELECT	16V	47µF	
C3001	ECUV1H222JCX	S.M. CAP	50V	2.2nF	
C3002	ECUV1H222JCX	S.M. CAP	50V	2.2nF	
C3003	ECA1CM470GB	ELECT	16V	47µF	
C3005	ECUV1H561JCX	S.M. CAP	50V	560pF	
C3006	ECJ3VB1C474K	ELECT	3.5KV	470nF	
C3007	ECUV1H222JCX	S.M. CAP	50V	2.2nF	
C3008	ECUV1H222JCX	S.M. CAP	50V	2.2nF	
C3009	ECUV1H222JCX	S.M. CAP	50V	2.2nF	
C3010	ECA1CM470GB	ELECT	16V	47µF	
C3012	ECUV1H561JCX	S.M. CAP	50V	560pF	
C3013	ECJ3VB1C474K	ELECT	3.5KV	470nF	
C3014	ECUV1H222JCX	S.M. CAP	50V	2.2nF	
C3015	ECUV1H222JCX	S.M. CAP	50V	2.2nF	
C3016	ECUV1H222JCX	S.M. CAP	50V	2.2nF	
C3017	ECA1CM470GB	ELECT	16V	47µF	
C3019	ECUV1H561JCX	S.M. CAP	50V	560pF	
C3020	ECJ3VB1C474K	ELECT	3.5KV	470nF	
C3021	ECUV1H222JCX	S.M. CAP	50V	2.2nF	
C3022	ECUV1H222JCX	S.M. CAP	50V	2.2nF	
C3023	ECUV1H222JCX	S.M. CAP	50V	2.2nF	
C3024	ECA1CM470GB	ELECT	16V	47µF	
C3026	ECUV1H561JCX	S.M. CAP	50V	560pF	
C3027	ECJ3VB1C474K	ELECT	3.5KV	470nF	
C3028	ECUV1H222JCX	S.M. CAP	50V	2.2nF	
C3029	ECA1HM101GB	ELECT	50V	100µF	
C3032	ECUV1H271JCX	S.M. CAP	50V	270pF	
C3033	ECUV1H271JCX	S.M. CAP	50V	270pF	
C3034	ECUV1H271JCX	S.M. CAP	50V	270pF	
C3035	ECUV1H271JCX	S.M. CAP	50V	270pF	
C3103	ECUV1H561JCX	S.M. CAP	50V	560pF	
C3104	ECUV1H561JCX	S.M. CAP	50V	560pF	
C3105	ECUV1H561JCX	S.M. CAP	50V	560pF	
C3106	ECUV1H561JCX	S.M. CAP	50V	560pF	
C3107	ECA1HM470GB	ELECT	50V	47µF	
C3108	ECA1HM470GB	ELECT	50V	47µF	
C3111	ECUV1H391JCX	S.M. CAP	50V	390pF	
C3112	ECUV1H271JCX	S.M. CAP	50V	270pF	
C3113	ECQB1H104J	FILM	50V	100nF	
C3114	ECQB1H104J	FILM	50V	100nF	
C3401	ECQB1H224J	ELECT	50V	220nF	
C3402	ECUV1H101JCX	S.M. CAP	50V	100pF	
C3403	ECA1HM101GB	ELECT	50V	100µF	
C3404	ECQB1H224J	ELECT	50V	220nF	
C3405	ECUV1H180JCX	S.M. CAP	50V	18pF	
C3406	ECUV1H271JCX	S.M. CAP	50V	270pF	

Cct Ref	Parts Number	Description			
C3407	ECUV1H271JCX	S.M. CAP	50V	270pF	
C3408	ECA1HM101GB	ELECT	50V	100µF	
C3601	ECA1HM101GB	ELECT	50V	100µF	
TERMINALS AND LINKS					
JK2301	JPJ841101320	RCA/HEADPHONEJACK			
JK3101	TJB16673	A.V. TERMINAL			
SWITCHES					
S801	ESB92S11B	SWITCH			▲
S1201	EVQ23405R	SWITCH			
S1202	EVQ23405R	SWITCH			
S1203	EVQ23405R	SWITCH			
S1204	EVQ23405R	SWITCH			
S1205	EVQ23405R	SWITCH			
DIFFERENCES FOR MODEL TX-25LD4C					
MECHANICAL PARTS					
13	TKU8E00310	BACK COVER			▲
14	A59ECF50X41	C.R.T.			▲
15	TKY8E210	CABINET			▲
16	TLK8E05138	DEGAUSS COIL			▲
17	TNP8EE009AH	E P.C.B.			▲
18	TQF8E2646	MODEL LABEL			▲
19	TSX8E0028	POWER CORD			▲
20	TNP8EY012AA	Y P.C.B.			▲
MISCELLANEOUS COMPONENTS					
	TPC8E4660-1	OUTER CARTON			
	TPD8E657	TOP CUSHION			
	TPD8E658	BOTTOM CUSHION			
I.C.s					
IC1103	XGL2-01C	EAROM *			
CAPACITORS					
C551	ECKC3D152J	CERAMIC	2KV	1.5nF	▲
DIFFERENCES FOR MODEL TX-28LD4C					
MECHANICAL PARTS					
13	TKU8E00320	BACK COVER			▲
14	A66ECF50X41	C.R.T.			▲
15	TKY8E300	CABINET			▲
16	TLK8E05140	DEGAUSS COIL			▲
17	TNP8EE009AB	E P.C.B.			▲
18	TQF8E2583	MODEL LABEL			▲
19	TSX8E0027	POWER CORD			▲
20	TNP8EY012AF	Y P.C.B.			▲
MISCELLANEOUS COMPONENTS					
	TPC8E4659	OUTER CARTON			
	TPD8E655	TOP CUSHION			
	TPD8E656	BOTTOM CUSHION			
I.C.s					
IC1103	XGL2-01AC	EAROM *			
CAPACITORS					
C551	ECKC3D122J	CERAMIC	2KV	1.2nF	▲

SCHEMATIC DIAGRAMS FOR MODELS





TX-28LD4C / TX-25LD4C

(EURO-4 CHASSIS)

IMPORTANT SAFETY NOTICE

Components identified by  mark have special characteristics important for safety. When replacing any of these components, use only manufacturer's specified parts.

NOTES

- RESISTOR**
All resistors are carbon $\frac{1}{4}W$ resistor, unless marked otherwise.
Unit of resistance is OHM (Ω) (K=1,000, M=1,000,000)
- CAPACITORS**
All capacitors are ceramic 50V unless marked otherwise
Unit of capacitance is μF unless otherwise stated.
- COIL**
Unit of inductance is μH , unless otherwise stated.
- Components marked "L" on the schematic diagram shows leadless parts.
- TEST POINT**
 :Test Point Position
- EARTH SYMBOL**
 Chassis Earth (Cold)  Line Earth (Hot)
- VOLTAGE MEASUREMENT**
Voltage is measured by a DC voltmeter
Measurement conditions are as follows:
Power source AC 220V-240V, 50Hz
Receiving Signal Colour Bar signal (RF)
All customer controls Maximum position
-  Indicates the Video signal path
 Indicates the Audio signal path

These schematic diagrams are the latest at time of printing and is subject to change without notice.

REMARKS

- The Power Supply Circuit contains a circuit area which uses a separate power supply to isolate the earth connection. The circuit is defined by HOT and COLD indications in the schematic diagram. All circuits except the Power Circuit, are COLD. Take the following precautions :-
 - Do not touch the hot part, or the hot and cold parts at the same time, as you are liable to a shock hazard.
 - Do not short circuit the hot and cold circuits as electrical components may be damaged.
 - Do not connect an instrument, such as an oscilloscope, to the hot and cold circuits simultaneously as this may cause fuse failure. Connect the earth of the instruments to the earth connection of the circuit being measured.
 - Make sure to disconnect the power plug before removing the chassis.

ZEICHENERKLÄRUNG FÜR MODELL





TX-28LD4C / TX-25LD4C

(EURO-4 CHASSIS)

WICHTIGER SICHERHEITSHINWEIS

Teile, die mit einen Hinweis  gekennzeichnet sind, sind wichtig für die Sicherheit, Sollte ein Auswechsein erforderlich sein, sind unbedingt Originalteile einzusetzen.

ANMERKUNG

- WIDERSTÄNDE**
Alle $\frac{1}{4}W$ Widerstände sind Kohlewiderstände, Abweichungen sind folgt gekennzeichnet.
Die Maßeinheit ist OHM (Ω) (K=1,000, M=1,000,000)
- KONDENSATOREN**
Alle Kondensatoren sind Keramikausführungen.
Spannungsfestigkeit 50V. Abweichungen sind wie folgt gekennzeichnet. Die Maßeinheit ist μF , wenn keine anderen Bezeichnungen genannt sind
- SPULEN**
Die Maßeinheit ist μH , Abweichungen sind gekennzeichnet.
- Mit "L" gekennzeichnete Teile sind ohne Anschlußdrähte.
- TESTPUNKTE**
 Kennzeichnung der Testpunktposition
- MASSE SYMBOL**
 Erdung am Chassis  Erdung an Masse-Leitung
- SPANNUNGSMESSUNG**
Spannungsmessungen sind mit einem DC-Voltmeter durchzuführen. Die Meßbedingungen sind folgende:
Netzspannung AC 220V-240V, 50Hz
Wiedergabe Signal Farbbalken-Testbild
Wiedergabesignal Farbbalken-Testbild (HF)
-  :Videosignalweg
 :Audiosignalweg

Änderungen im Laufe der Fertigung sind möglich.

BEMERKUNGEN

- Das Schaltnetzteil enthält Bereiche, die direkt mit dem Netz verbunden sind. Diese Bereiche sind im Schaltplan mit HOT gekennzeichnet. Alle anderen Schaltungen sind mit COLD gekennzeichnet und haben keine direkte Verbindung mit den Netz :-
 - Weder die Leitungen im heißen noch Leitungen im kalten Bereich gleichzeitig berühren. Es besteht die Gefahr eines elektrischen Schlages.
 - Keinesfalls die Leitungen im heißen Bereich mit denen im kalten Bereich verbinden oder kurzschliessen. Dies kann zur Zerstörung von Bauteilen oder Sicherungen führen. Außerdem ist die elektrische Betriebssicherheit des Gerätes nicht mehr gegeben.
 - Keine Messinstrumente gleichzeitig an Leitungen im heißen und kalten Bereich anschliessen. Sicherungen könnten zerstört werden. Die Erde des Messinstrumentes immer mit der des zu prüfenden Schaltkreises verbinden.
 - Vor Ausbau des Chassis, Stecker aus der Netzsteckdose ziehen.

Y BOARD ⚠
TNP8EY012

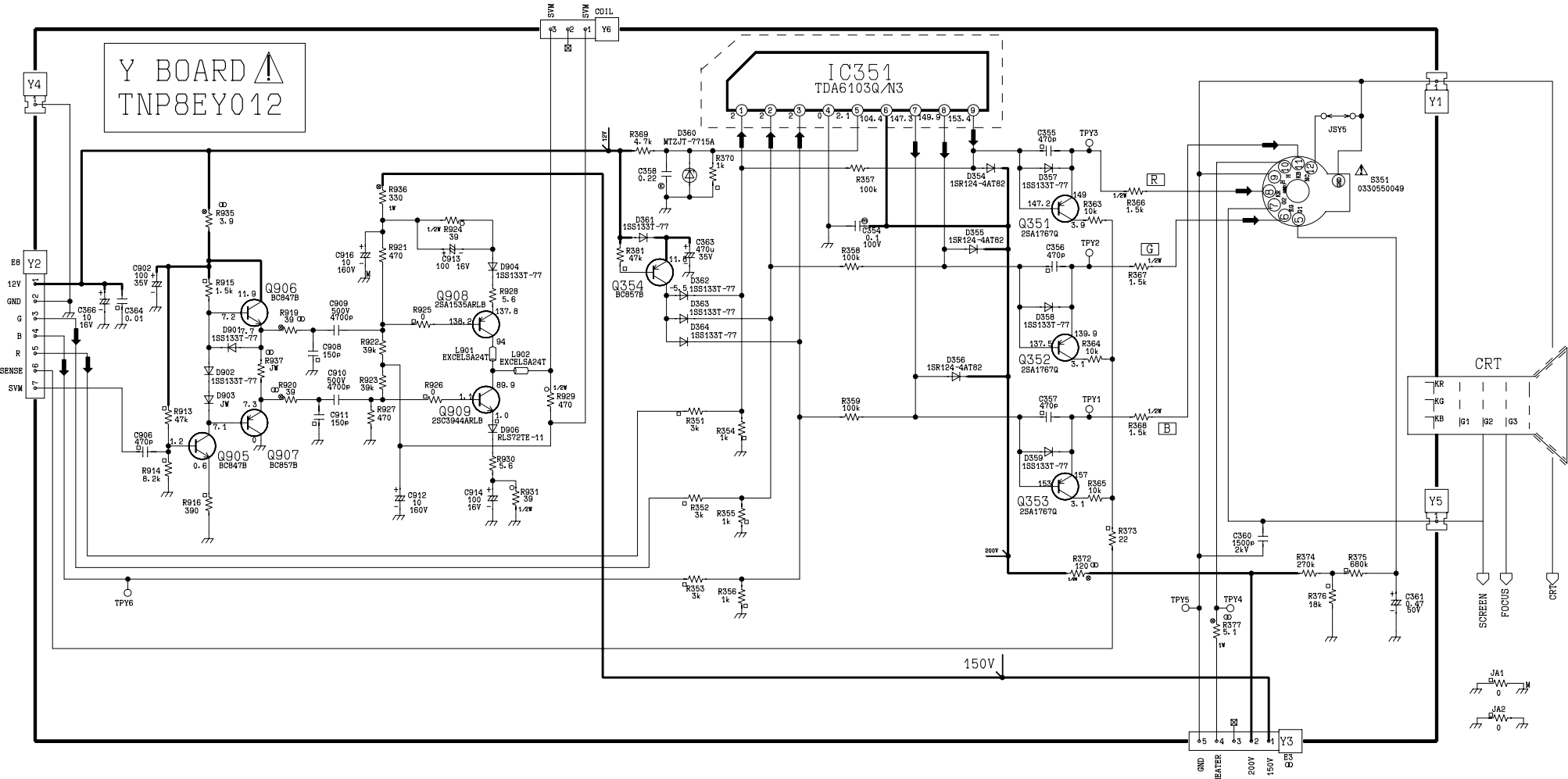

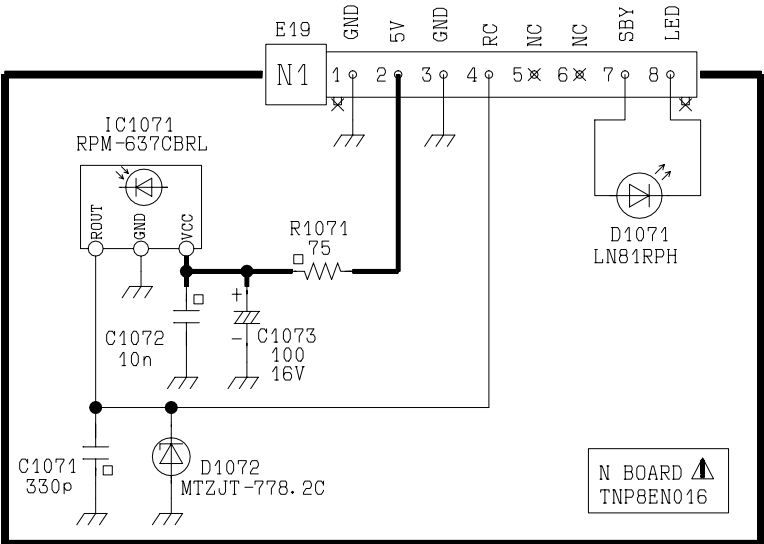

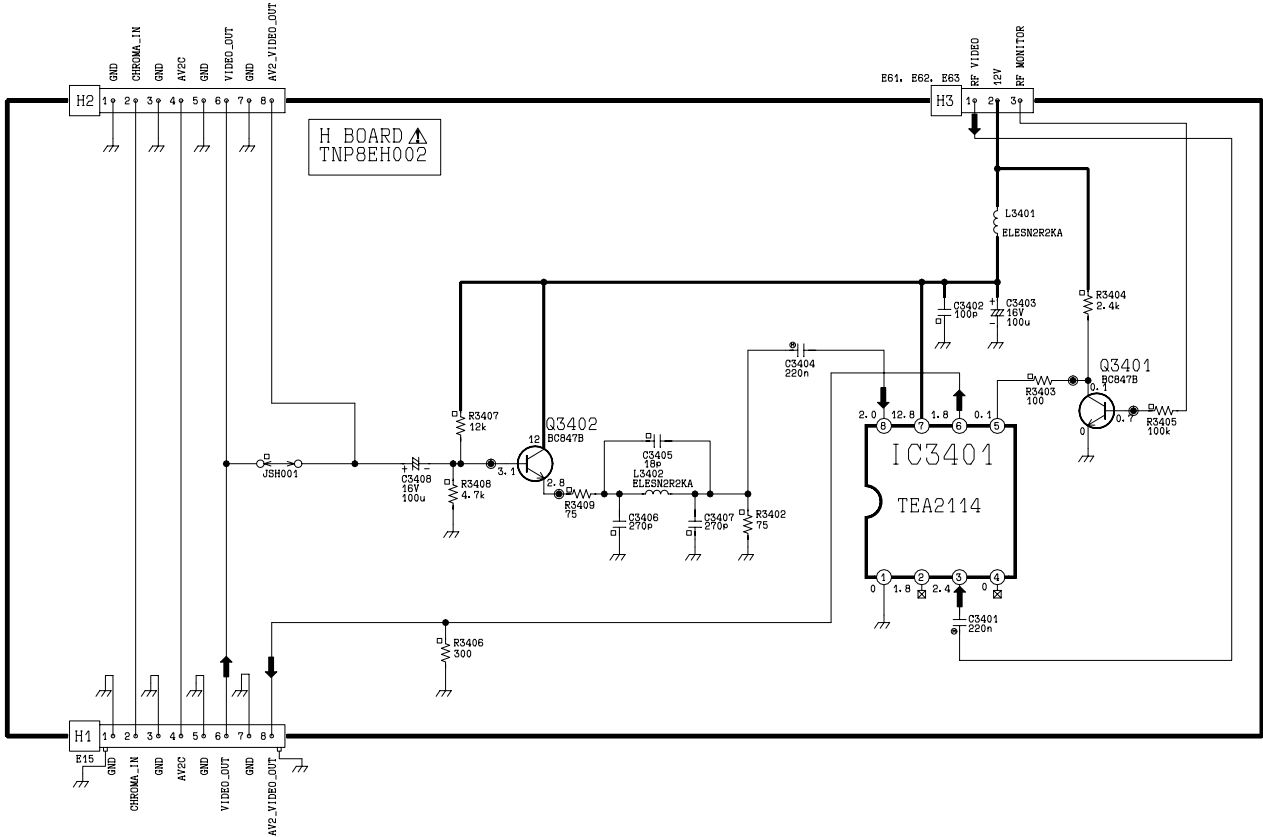

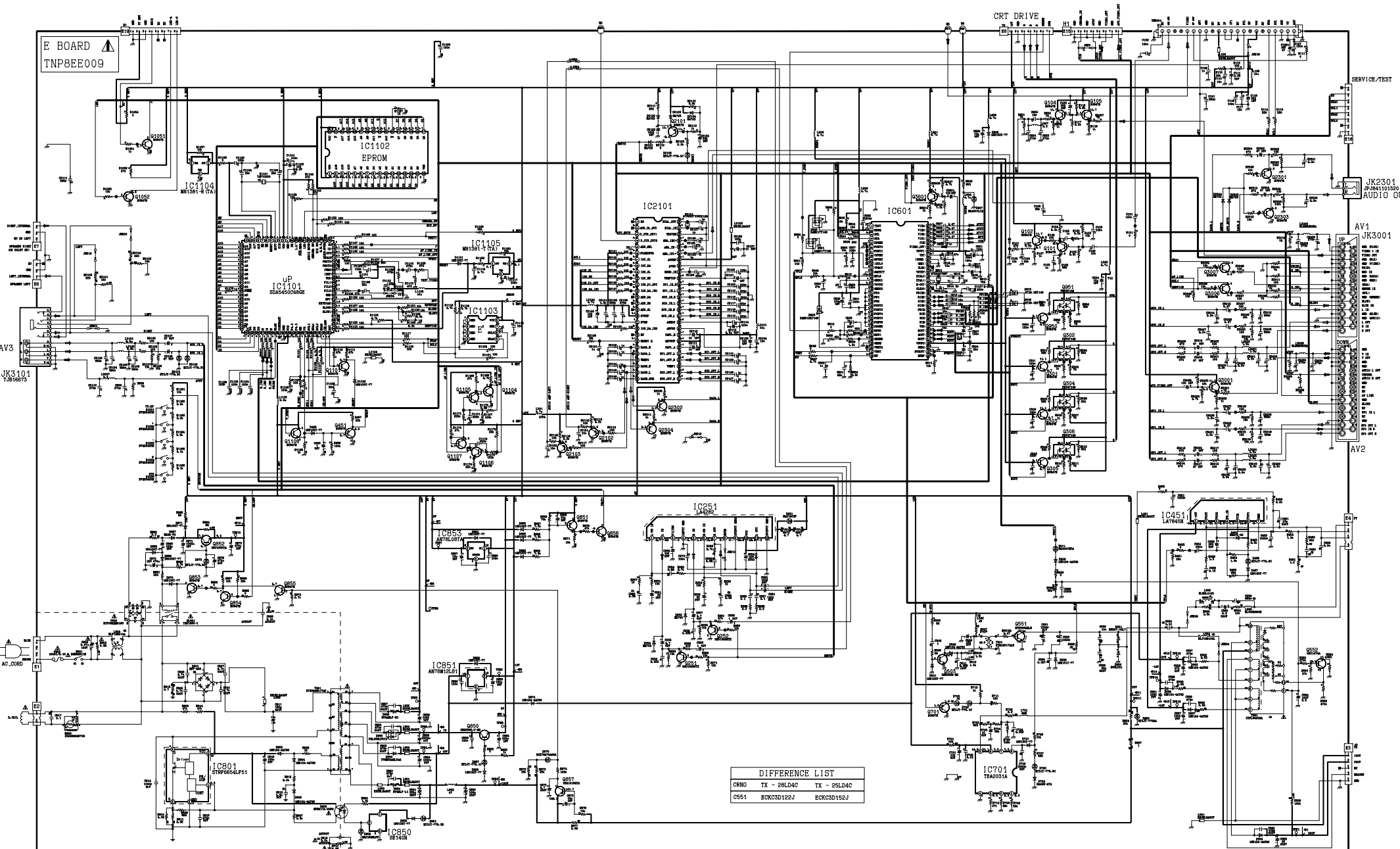

E BOARD
TNP8EE009

UP
IC1101
28A450080E

IC1102
EPROM

IC2101

IC601

IC251

IC855

IC851

IC801

IC451

IC701

DIFFERENCE LIST

ORND	TX - 28LD4C	TX - 28LD4C
C551	EKC3D122J	EKC3D152J

JK2301
28410300
AUDIO OUT

AV1
JK3001

AV2

CRT DRIVE

SERVICE/TEST

AV3
JK3101
10816075

AC_OUT

100V 50/60Hz

100V 50/60Hz

100V 50/60Hz

100V 50/60Hz

100V 50/60Hz

100V 50/60Hz

E-BOARD TNP8EE009

TRAN'S	DIODES	D558	L4		
Q3601	L8	D3103	B7	D557	M4
Q3007	M9	D3101	B7	D556	K1
Q3001	N8	D3102	B7	D555	N3
Q3006	N10	D2161	G9	D554	M4
Q2304	I7	D2105	G10	D553	K4
Q2303	M6	D2104	F9	D552	J2
Q2301	I7	D2103	G10	D551	K3
Q2103	I8	D2102	G9	D511	M5
Q2102	H8	D1103	F8	D502	I2
Q2101	G10	D1102	F7	D501	I2
Q1108	F9	D1101	G7	D457	L5
Q1107	C7	D1051	A9	D456	L5
Q1106	C7	D875	J5	D454	L5
Q1105	C7	D874	J4	D453	F9
Q1104	C7	D873	B5	D254	C5
Q1101	F7	D871	A5	D253	C5
Q1052	A9	D870	871	D252	B5
Q1051	C8	D869	B4	D251	B4
Q951	J9	D868	B4	IC'S	
Q950	J9	D867	A3	IC2101	H8
Q857	J4	D866	I9	IC1105	F7
Q856	F9	D865	I9	IC1104	C9
Q855	J5	D864	I10	IC1103	F8
Q854	B4	D863	G9	IC1102	D10
Q853	B4	D862	N10	IC1101	D8
Q852	B5	D861	J9	IC1051	A10
Q850	F5	D860	I10	IC852	I10
Q701	J5	D859	H5	IC851	G5
Q552	N3	D858	E5	IC850	H4
Q551	K1	D857	E5	IC801	G2
Q503	I2	D855	F4	IC701	K5
Q451	F8	D854	G4	IC601	L7
Q394	K9	D853	H3	IC451	L5
Q305	K9	D852	I4	IC251	D6
Q303	K9	D851	I4	TP'S	
Q302	J9	D850	H4	TPE14	M5
Q301	K9	D806	G2	TPE13	M4
Q253	C4	D805	H2	TPE12	K4
Q252	C4	D804	H1	TPE11	N5
Q252	C4	D803	H1	TPE10	B5
Q251	D4	D802	G2	TPE9	E5
Q105	M8	D801	E1	TPE8	F5
Q104	M9	D705	J5	TPE7	I9
Q103	F10	D704	K5	TPE6	J10
Q102	G10	D703	K5	TPE5	G5
Q101	H10	D702	K5	TPE4	G5
		D701	K5	TPE3	E5
		D609	M5	TPE2	I5
		D607	L9	TPE1	M4

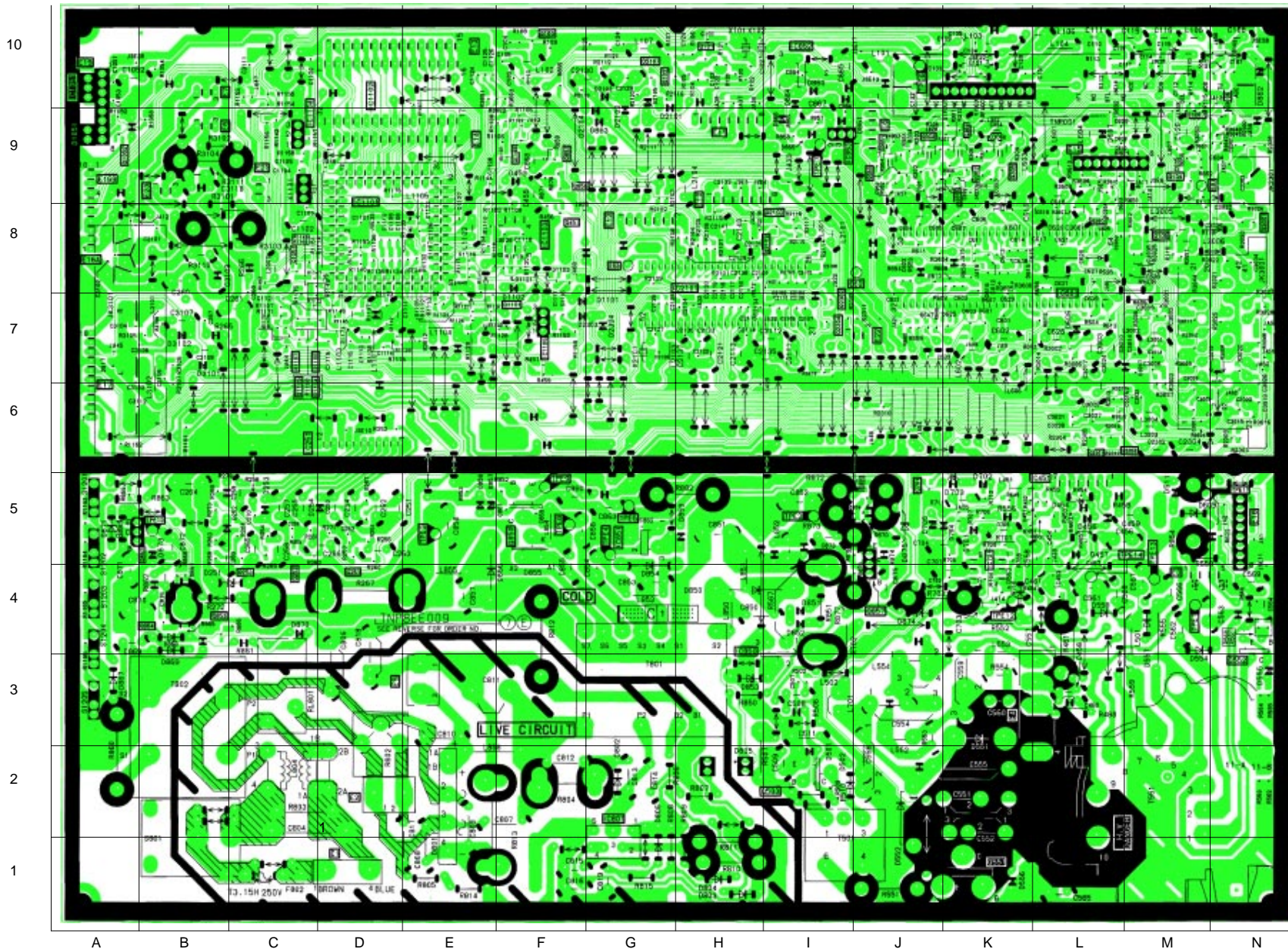

Y - BOARD TNP8EY012

TRANSISTORS

Q909	B4
Q908	B6
Q907	D3
Q906	D2
Q905	D3
Q354	G7
Q353	F2
Q352	F3
Q351	F3

DIODES

D906	B3
D905	D2
D904	C5
D903	D2
D902	D2
D901	D2
D364	I6
D363	H6
D362	I6
D361	G7
D360	H5
D359	F2
D358	G4
D357	G3
D356	G2
D355	G3
D354	G2

TEST POINTS

TPY6	H7
TPY5	E5
TPY4	E4
TPY3	F2
TPY2	G4
TPY1	F2

IC'S

IC351	G5
-------	----

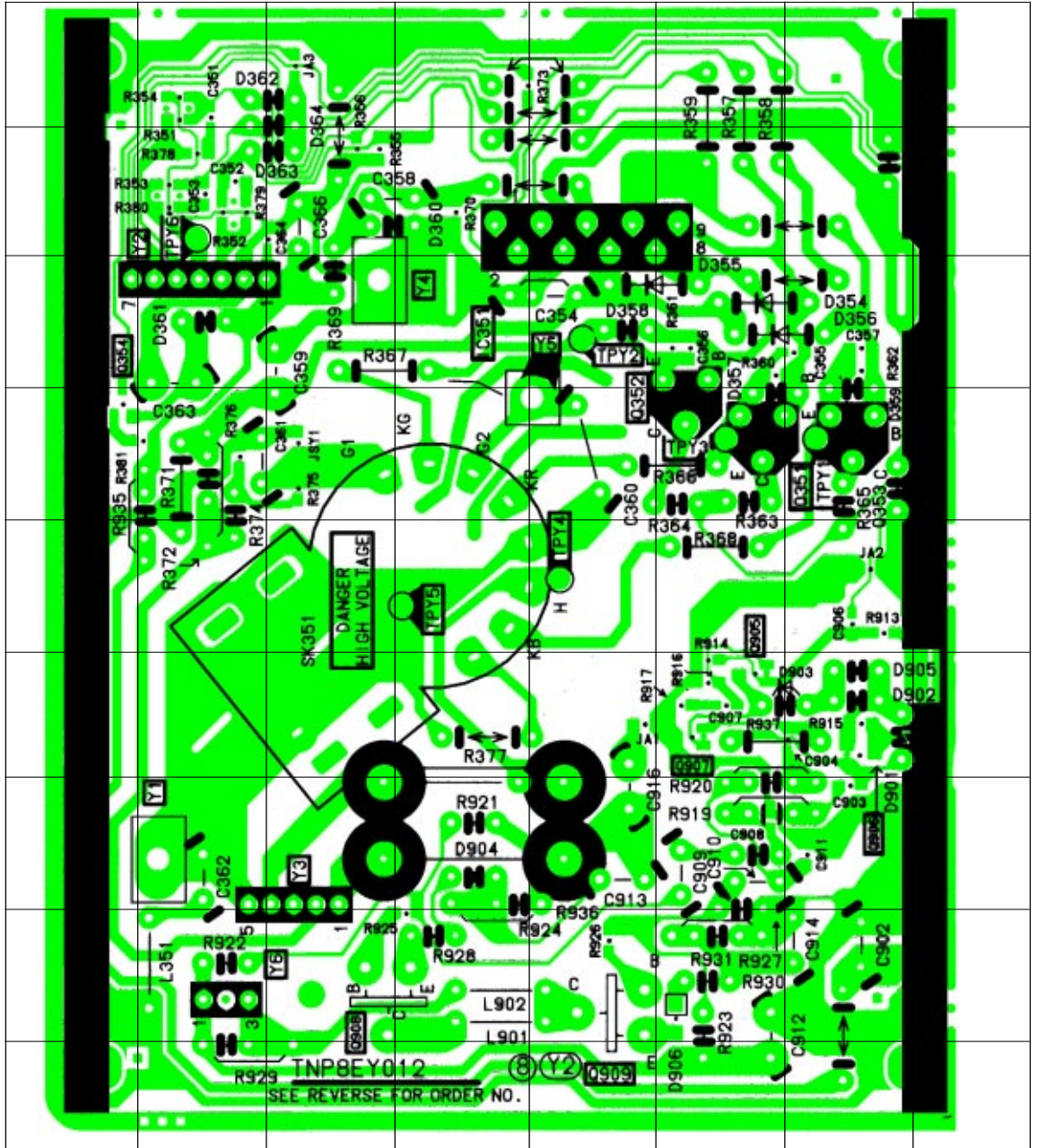

TNP8EY012
SEE REVERSE FOR ORDER NO.

8

7

6

5

4

3

2

1

I

H

G

F

E

D

C

B

A